



Einbauanleitung

Installation instruction



R4 SF H/K 200/100



Deutschland

Hinweise/Sicherheitshinweise

- Bitte bewahren Sie die Anleitung auf!
- Die allgemeinen Unfallverhütungsvorschriften bei Dacharbeiten beachten.
- Die Baustelle gegen herabfallende Teile sichern.
- Bauphysikalische Grundlagen wie Wärmedämmung, Feuchteschutz, Regensicherheit/Wasserdichtheit und Lärmschutz beachten.
- Die Zahlen geben immer die Reihenfolge der Montage an!
- Technische Änderungen vorbehalten.

⚠ Eingriffe in Tragwerkstrukturen dürfen nur von qualifizierten Fachkräften ausgeführt werden!

In Gebieten mit Schneefall ist oberhalb des Fensters eine Schneefangeinrichtung zu montieren.

Für Einbualatten nur Holz der Sortierklasse S. 13 verwenden. Die Höhen der Dachlatten und die Höhe der Einbualatten müssen gleich sein!

Verwenden Sie nur unveränderte Roto Originalteile.

Halten Sie Personen aus dem Fahrbereich der Anlagen fern!

Halten Sie Kinder von Steuerungen fern!

Beachten Sie Ihre landesspezifischen Bestimmungen.

Wird die Anlage durch einen oder mehrere Bedienelemente gesteuert, muß der Fahrbereich der Anlage während des Betriebs einsehbar sein.

Technischen Daten:

Steuerung

Batteriepack:	12 V DC / min 2000 mAh
Eingang PV:	12 V DC / 0,5 A
Nennausgangsspannung M3:	12 V DC
Zulässiger Ausgangsstrom M3:	max. 2,5 A
Nennausgangsspannung M1, M2:	24 V DC
Zulässiger Ausgangsstrom M1, M2:	je 0,5 A
Schutzart:	IP 20

Technischen Daten:

Antrieb

Druckkraft (max.):	300 N
Zugkraft (max.):	300 N
Laufzeit:	20s/ 100mm
Schutzart:	IP 50
Versorgung:	24 V DC / 0,5 A

(AC= Wechselfspannung)

(DC= Gleichspannung)

(rel. H= relative Luftfeuchtigkeit)

France

Conseil/ Recommandation de sécurité

- Veuillez conserver ces instructions.
- Respecter le règlement général de prévention des accidents pour les travaux sur le toit.
- Assurer le chantier contre la chute de matériaux.
- Respecter les conditions de base relatives à la physique de bâtiment telles que l'isolation thermique, la protection contre l'humidité, contre la pluie/étanchéité à l'eau et protection contre le bruit.
- Les chiffres indiquent toujours l'ordre du montage !
- Sous réserve de modifications.

⚠ Les interventions au niveau éléments porteurs ne doivent être réalisées que par une main-d'œuvre qualifiée!

Dans les régions avec chutes de neige, un pare-neige doit être monté au-dessus de la fenêtre.

Pour les lattes d'installation, utiliser exclusivement du bois sans noeuds et sans fissures. L'épaisseur des liteaux et l'épaisseur des lattes d'installation doivent être identiques!

Utiliser uniquement des pièces d'origine Roto non modifiées.

Tenir les enfants à distance de la zone de déplacement des installations.

Tenir les enfants à distance des commandes.

Respecter les prescriptions nationales.

Si l'installation est commandée par un ou plusieurs éléments de commande, la zone de déplacement de l'installation doit être bien visible pendant l'exploitation.

Caractéristiques techniques:

Commande

Batterie:	12 V DC / min 2000 mAh
Entrée PV:	12 V DC / 0,5 A
Tension nominale de sortie M3 :	12 V DC
Courant de sortie admissible M3 :	max. 2,5 A
Tension nominale de sortie M1, M2 :	24 V DC
Courant de sortie admissible M1, M2 :	0,5 A chacune
Type de protection :	IP 20

Caractéristiques techniques:

Motorisation

Force de pression (max.) :	300 N
Force de traction (max.) :	300 N
Temps de fonctionnement :	20 s/100 mm
Type de protection :	IP 50
Alimentation :	24 V DC/0,5 A

(AC= Tension alternative)

(DC= Tension continue)

(rel. H= Humidité relative de l'air)



Great Britain **Safety advice/recommendations**

- Please keep these instructions in a safe place.
- Observe the general regulations for prevention of accidents concerning work on the roof.
- Secure site against falling parts.
- Observe basics of building physics, as heat insulation, protection against moisture, rain shielding/waterproofness, and noise protection.
- The numbers specify the assembly sequence.
- We reserve the right to make any amendment.

 Work on the frame structure may only be performed by qualified personnel!

In areas with snowfall, protection or a deflector should be provided above the window.

For installation laths, use wood of the grading class MS 13/C35 only. The thickness of the roof battens and the thickness of the installation laths have to be identical!

Use only unmodified original Roto parts.

Keep children away from the operating range of power drives.

Keep children away from controllers.

Refer to the specifications in your national language.

If the equipment is controlled by one or more controls, the operating range of the equipment must be visible whilst operating the controls.

Technical data:

Controller

Battery pack:	12 V DC / min 2000 mAh
Input PV:	12 V DC / 0,5 A
Nominal output voltage M3:	12 V DC
Permissible output current M3:	max. 2,5 A
Nominal output voltage M1, M2:	24 V DC
Permissible output current M1, M2:	0,5 A each
Index of Protection:	IP 20

Technical data:

Drive

Opening force (max.):	300 N
Closing force (max.):	300 N
Running time:	20 s / 100 mm
Index of Protection:	IP 50
Power supply:	24 V DC / 0,5 A

(AC= Alternating Current)

(DC= Direct Current)

(rel. H= relative atmospheric Humidity)

Nederland/Belgique **Veiligheid/aandachtspunten**

- Bewaar de handleiding.
- U dient bij werkzaamheden aan/op het dak de algemene voorschriften ter voorkoming van ongevallen in acht te nemen.
- U dient de bouwplaats tegen neervallende delen te beveiligen.
- U dient de bouwkundige principes zoals warmte-isolatie, vochtwering, bescherming tegen regenwater/waterdichtheid en geluidswering in acht te nemen.
- De getallen geven altijd de volgorde van de montage-werkzaamheden aan!
- Technische veranderingen voorbehouden.

 Ingrepen in de draagconstructies mogen uitsluitend door daartoe gekwalificeerd personeel worden uitgevoerd!

In gebieden met sneeuwval moet boven het raam een sneeuwvanginrichting worden gemonteerd.

Voor inbouwlaten mag u alleen hout van sorteerklassen S13 gebruiken. De hoogte van de daklaten en de hoogte van de inbouwlaten moeten gelijk zijn!

Gebruik uitsluitend ongewijzigde, originele onderdelen van Roto.

Houd kinderen buiten de actieradius van de installaties.

Laat kinderen niet aan de besturingen komen.

Neem de nationale bepalingen in acht.

Als de installatie door een of meer bedieningselementen wordt aangestuurd, moet de actieradius van de installatie tijdens werking kunnen worden overzien.

Technical data:

Besturing

Battery pack/Accu:	12 V DC / min 2000 mAh
PV-ingang:	12 V DC / 0,5 A
Nom. uitgangsspanning M3:	12 V DC
Toegestane uitgangsstroom M3:	max. 2,5 A
Nom. uitgangsspanning M1, M2:	24 V DC
Toegestane uitgangsstroom M1, M2:	elk 0,5 A
Beschermingsgraad:	IP 20

Technical data:

Aandrijving

Drukkracht (max.):	300 N
Trekkracht (max.):	300 N
Looptijd:	20 s / 100 mm
Beschermingsgraad:	IP 50
Voeding:	24V DC/0,5A

(AC= wisselspanning)

(DC= gelijkspanning)

(rel. H= relatieve vochtigheid)

España

Consejo/recomendación de seguridad

- Por favor, conserve las instrucciones.
- Tenga en cuenta las prescripciones generales de prevención de accidentes para trabajos en el tejado.
- Asegure la obra contra objetos que pudieran caer.
- Tenga en cuenta los principios físicos constructivos tales como aislamiento térmico, protección contra la humedad, seguridad contra el agua y protección contra el ruido.
- Los números indican siempre el orden de montaje.
- A reserva de modificaciones.

⚠ Cualquier modificación en los elementos estructurales debe ser realizada únicamente por personal especializado!

En las zonas donde se presentan nevadas debe montarse un dispositivo paranieves por encima de la ventana.

Utilizar únicamente madera de la clase de selección MS 13 para los listones que se desean. La altura de los listones del tejado y de los listones que se desean montar debe ser igual!

Utilice solamente piezas originales Roto no modificadas.

No deje que los niños se acerquen al área de desplazamiento de la instalación.

No deje los controles al alcance de los niños.

Tenga en cuenta las disposiciones pertinentes de su país.

Si la instalación es controlada mediante uno o varios elementos de mando, debe poderse ver el área de desplazamiento de la instalación durante el funcionamiento.

Datos técnicos:

Mando

Paquete de la batería:	12 V DC / min 2000 mAh
Entrada de PV:	12 V DC / 0,5 A
Tensión nominal de salida M3:	12 V DC
Corriente de salida permitida M3:	max. 2,5 A
Tensión nominal de salida M1, M2:	24 V DC
Corriente de salida permitida M1, M2:	0,5 A, respectivamente
Tipo de protección:	IP 20

Datos técnicos:

Accionamiento

Fuerza de presión (máx.):	300 N
Fuerza de tracción (máx.):	300 N
Tiempo de funcionamiento:	20 s / 100 mm
Tipo de protección:	IP 50
Alimentación:	24V CC / 0,5 A

(AC= tensión alterna)

(DC= tensión continua)

(rel. H= humedad relativa de la atmósfera)

Portugal

Conselhos/recomendações de segurança

- Guarde o manual.
- Cumpra com as normas gerais para a prevenção de acidentes.
- Proteja o local da construção contra a queda de quaisquer peças.
- Atenda aos princípios fundamentais fisicotécnicos da construção civil, tais como isolamento térmico, protecção anti-humidade, segurança pluvial/impermeabilidade à água e protecção contra a poluição sonora.
- Os algarismos indicam sempre a ordem da montagem!
- Sob reserva de modificações.

⚠ A realização de toda e qualquer intervenção nos vigaamentos só está autorizada a pessoal especializado devidamente qualificado!

Em zonas com neve, é necessário montar um dispositivo colector de neve por cima da janela.

Utilize exclusivamente madeira da classe de qualidade S 13 para as fasquias de montagem. Tanto as alturas das ripas do telhado como a altura das fasquias de montagem deverão ser idênticas!

Utilize apenas peças originais inalteradas Roto.

Mantenha as crianças afastadas da área de trabalho das instalações.

Mantenha os comandos fora do alcance das crianças.

Respeite os regulamentos específicos do seu país.

Se o instalação for controlada por um ou mais elementos de comando, a área de trabalho da instalação tem de estar visível durante o funcionamento.

Dados técnicos:

Comando

Bateria:	12 V DC / min 2000 mAh
Entrada PV:	12 V CC / 0,5 A
Tensão nominal de saída M3:	12 V CC
Corrente de saída admissível M3:	max. 2,5 A
Tensão nominal de saída M1, M2:	24 V CC
Corrente de saída admissível M1, M2:	cada 0,5 A
Grau de protecção:	IP 20

Dados técnicos:

Automatismo

Força de compressão (máx.):	300 N
Força de tracção (máx.):	300 N
Tempo de abertura:	20 s / 100 mm
Grau de protecção:	IP 50
Alimentação eléctrica:	24 V DC / 0,5 A

(CA= Corrente alternada)

(CC= Corrente contínua)

(H. rel. = humidade relativa)



Polska

Wskazówki/wskazówki bezpieczeństwa

- Proszę zachować instrukcję.
- Należy przestrzegać ogólnych przepisów bezpieczeństwa pracy przy robotach dachowych.
- Zabezpieczyć miejsce budowy przed spadającymi częściami.
- Przestrzegać przy montażu podstaw fizyki budowlanej takich jak: izolacja cieplna, ochrona przeciwwilgociowa, zabezpieczenie przed deszczem/wodoszczelność i dźwiękoszczelność.
- Cyfry podają kolejność montażu!
- Zmiany techniczne zastrzeżone.

 Wszelkich ingerencji w konstrukcję nośne mogą dokonywać wyłącznie wykwalifikowani fachowcy!

W rejonach z opadami śniegu należy powyżej okna zamontować dachową barierę przeciwnięgową.

Do montażu stosować wyłącznie łąty z drewna o jakości klasy I. Grubość łąt dachowych i łąt montażowych musi być identyczna!

Proszę stosować tylko niezmienione części oryginalne Roto.

Nie należy zezwalać dzieciom na zbliżanie się do obszaru działania urządzeń.

Nie należy zezwalać dzieciom na zbliżanie się do urządzeń sterujących.

Należy przestrzegać krajowych przepisów bezpieczeństwa i montażu.

Jeżeli układ sterowany jest przez jeden element obsługi lub więcej, urządzenie musi być widoczne podczas pracy.

Dane techniczne:

Sterownik

Akumulator:	12 V DC / min 2000 mAh
Wejście PV:	12 V DC / 0,5 A
Napięcie znamionowe wyjścia M3:	12 V DC
Dopuszczalne natężenie wyjścia M3:	max. 2,5 A
Napięcie znamionowe wyjścia M1, M2:	24 V DC
Dopuszczalne natężenie wyjścia M1, M2:	0,5 A (każde)
Rodzaj ochrony:	IP 20

Dane techniczne:

Napęd

Siła nacisku (maks.):	300 N
Siła ciągu (maks.):	300 N
Czas cyklu pracy:	20 s / 100 mm
Rodzaj ochrony:	IP 50
Zasilanie:	24 V DC / 0,5 A

(AC= napięcie przemienne)

(DC= napięcie stałe)

Россия/ Україна

Указания/рекомендации по безопасности

- Сохраняйте данную инструкцию!
- Ознакомьтесь с общими указаниями во избежание травматизма при работе на крыше:
- Обезопасьте строительную площадку на случай падения используемого материала / инструмента.
- При монтаже соблюдайте основные принципы из области строительной физики, такие как тепло-, паро-, гидро- и звукоизоляция.
- Цифры на рисунках показывают последовательность их монтажа!
- Производитель оставляет за собой право на внесение изменений.

 Работы с несущими конструкциями здания и любые изменения в них могут производиться только квалифицированным персоналом!

В районах, где выпадает снег, установить поперек окна приспособление для удержания снега.

Для монтажных реек должна использоваться древесина первого сорта. Высота обрешетки (контрбруса) и высота монтажных реек должна быть одинаковой!

Просим применять только оригинальные части Roto.

Не позволяйте детям приближаться к зоне действия оборудования.

Не позволяйте детям приближаться к элементам управления.

Соблюдайте правила безопасности и монтажа.

Если система работает с одним или несколькими элементами управления, то устройство должно быть видимым во время работы.

Технические характеристики:

Система управления

Аккумулятор:	12 В DC / min 2000 mAh
Вход PV:	12 В DC / 0,5 А
Номинальное напряжение на выходе M3:	12 В DC
Допускаемая сила тока M3:	max. 2,5 А
Номинальное напряжение на выходе M1, M2:	24 В DC
Допускаемая сила тока на выходе M1, M2:	0,5 А (каждая)
Вид защиты:	IP 20

Технические характеристики:

Привод

Прижимное усилие (макс.):	300 Н
Тяговое усилие (макс.):	300 Н
Время работы:	20 с / 100 мм
Вид защиты:	IP 50
Питание:	24В пост.т. / 0,5 А

(AC – переменное напряжение)

(DC – постоянное напряжение)

Eesti

Näpunäited/ohutusjuhend

- Soovitame käesolev juhend õige kasutuse ja hoolduse meeldetuletamiseks alles hoida.
- Katusel töötades tuleb pidada kinni üldistest ohutustehnika eeskirjadest.
- Kaitsta objekt ülevalt kukkuda võivate materjalide ja tööriistade eest.
- Paigalduse käigus pidada kinni ehitusfüüsika põhialustest: lengiümbruse soojusisolatsioon, veekindlus, aurutõke seestpoolt, heliisoatsioon.
- Numbrid juhise pildidel näitavad paigaldusetappide järjekorda!
- Tootja jätab endale õiguse tehniliste muudatuste siseseviimiseks.

- ⚠ Katuse kandekonstruktsioonid võivad muuta ainult vastavat kvalifikatsiooni omavad töötajad!

Lumesajuga piirkondades tuleb monteerida akna kohale lumepüüdur.

Akna paigalduslattidena kasutada ainult 1. klassi puitu. Roovlattice ja akna paigalduslattice paksus peab olema võrdne!

Kasutage ainult Roto originaal detaile.

Hoidke lapsi akent avavast/sulgevast mootorist eemal.

Hoidke lapsed puldist eemal.

Pidage silmas antud ala reguleerivad ning

analoogsete seadmete paigaldamist reguleerivaid kohalikke normatiivakte.

Kui puldist juhitakse üht või mitut seadet, siis kõik seadmed peavad nende tööprotsessi ajal näha olema.

Tehnilised andmed:

Juhtsüsteem

Battery Pack / akut:	12 V DC / min 2000 mAh
PV sisend:	12 V DC / 0,5 A
Väljuv nominaalpinge M3:	12 V DC
Lubatud M3 väljundvool:	max 2,5 A
Väljuv nominaalpinge M1, M2:	24 V DC
Lubatud M1, M2 väljundvool:	kummalegi 0,5 A
Kaitseklass:	IP 20

Tehnilised andmed:

Ajam

Survejõud (max):	300 N
Tõmbejõud (max):	300 N
Tööaeg:	20 s / 100 mm
Kaitseklass:	IP 50
Toide:	24 V DC / 0,5 A

(AC= vahelduvvool)

(DC= alalisvool)

(rel. H= suhteline õhuniiskus)

Latvija

Norādījumi/drošības norādījumi

- Lūdzu saglabājiet instrukciju .
- Jāievēro vispārējie drošības darba pasākumi pie jumta darbiem.
- Nodrošināt, lai celtniecības vietu neapdraud krītošas konstrukcijas vai priekšmeti.
- Veicot montāžu jāievēro fizikas pamatlikumi, tādi kā: termoizolācija, aizsardzība pret mitrumu, nodrošinājums pret lietu un skaņas izolācija.
- Cipari norāda montāžas secību.
- Pielaujamas tehniskas izmaiņas.

- ⚠ Jebkādus uzlabojumus nesošajās konstrukcijās var veikt tikai kvalificēti darbnieki!

Reģionos, kur snieg sniegs, virs loga ir jāuzmontē sniega savācējs.

Montāžai lietot tikai pirmšķirīgas kvalitātes koka latas. Latām jumta latojumā jābūt vienādā biezumā!

Izmantojiet vienīgi nepārveidotas Roto oriģināldetaļas.

Neielaist bērnus iekārtas pārvietošanās sfērā.

Nelaist bērnus pie vadības ierīcēm. Lūdzu ievērot Jūsu valsts īpašos noteikumus.

Ja iekārta tiek vadīta ar vienu vai vairākiem apkalpes elementiem, iekārtas pārvietošanās sfērai darbības laikā jābūt pārskatāmai.

Tehnisie dati:

Vadības sistēma

Akumulators:	12 V DC / min 2000 mAh
PV ievade:	12 V DC / 0,5 A
Nominālais izejas spriegums M3:	12 V DC
Pielaujamā izejas strāva M3:	max. 2,5 A
Nominālā izejas strāva M1, M2:	24 V DC
Pielaujamā izejas strāva M1, M2:	je 0,5 A
Aizsardzība:	IP 20

Tehnisie dati:

Piedziņa

Spiedes spēks (maks.):	300 N
Vilces spēks (maks.):	300 N
Darbības laiks:	20 s / 100 mm
Aizsardzība:	IP 50
Spriegums:	24 V DC / 0,5 A

(AC= mainstrāva)

(DC= līdzstrāva)

(rel. H= relatīvais gaisa mitrums)



Lietuva

Nurodymas/saugumo taisyklės

- Saugoti instrukciją.
- Būtina imtis bendrų darbo saugumo priemonių.
- Apsaugoti darbo vietą nuo krentančių elementų.
- Laikytis statybinų normų reikalavimų šilumos izoliacijai, drėgmės izoliacijai, nepralaidumo lietaus vandeniui, garso izol. iacijai.
- Skaičiai paveikslėliuose parodo montavimo eiliškumą. Galimi techniniai pakeitimai.
- Bet kokius pakeitimus lango konstrukcijoje gali atlikti tik kvalifikuotas personalas!



Vietovėse, kur sninga, virš lango pritvirtinti sniego sulaikymo įtaisų.

Jeigu, montuojant stogo langus, neužtenka atstumo tarp gegnių, stogo konstrukcijos perdarymas galimas tik iš tokios pat medienos kaip ir gegnės!

Prašome naudoti tikta nenaudotas ir originalias Roto detales.

Negalima leisti vaikų prie prietaisų.

Neleisti vaikams prisirtinti prie valdančiųjų įtaisų.

Reikia laikytis saugos bei montavimo taisyklių.

Valdant viena ar daugiau elementų, tai įranga turi būti matoma veikimo metu.

Techniniai duomenys:

Valdymas

Baterija:	12 V DC / min 2000 mAh
PV įvestis:	12 V DC / 0,5 A
Nominali išėjimo įtampa M3:	12 V DC
Leidžiama srovė M3:	max. 2,5 A
Nominali išėjimo įtampa M1, M2:	24 V DC
Leidžiama išeinamoji srovė M1, M2:	0,5 (kiekviena)
Apsaugos tipas:	IP 20

Techniniai duomenys:

Pavara

Slėgio jėga (maks.):	300 N
Tempimo jėga (maks.):	300 N
Eigos laikas:	20 s / 100 mm
Apsaugos tipas:	IP 50
Maitinimas:	24 V DC / 0,5 A

(AC= kintama įtampa)

(DC= nuolatinė įtampa)

Česká republika

Doporučení/bezpečnostní upozornění

- Dodržujte prosím návod.
- Dodržujte všeobecné bezpečnostní předpisy pro práci na střeše.
- Zajistěte staveniště proti případnému pádu dílů.
- Respektujte stavebně-fyzikální podklady týkající se tepelné izolace, ochrany proti vlhkosti, vodotěsnosti při dešti a sněžení a ochraně proti hluku.
- Čísla vždy vyjadřují posloupnost jednotlivých kroků montáže!
- Technické změny vyhrazeny.



Zásahy do nosné konstrukce střešy mohou provádět jen kvalifikovaní pracovníci!

Ve sněhových oblastech je třeba nad oknem namontovat zařízení k zachycení sněhu.

Pomocné montážní latě musejí být ze dřeva bez suků a prasklin. Výška střešních latí a pomocných montážních latí musí být stejná!

Používejte jen neupravené originální díly ROTO.

Zamezte dětem přístup do pracovního prostoru zařízení.

Uložte ovladače mimo dosah dětí.

Dbejte specifických předpisů platných ve Vaší zemi.

Bude-li zařízení ovládáno jedním nebo více ovladači, musí být během pohybu akční radius zařízení opticky kontrolovatelný.

Technické údaje:

Řízení

Battery Pack / baterie:	12 V DC / min 2000 mAh
PV vstup:	12 V DC / 0,5 A
Jmenovité výstupní napětí M3:	12 V DC
Přípustný výstupní proud M3:	max. 2,5 A
Jmenovité výstupní napětí M1, M2:	24 V DC
Přípustný výstupní proud M1, M2:	á 0,5 A
Druh ochrany:	IP 20

Technické údaje:

Pohon

Tlaková síla (max.):	300 N
Tažná síla (max.):	300 N
Doba chodu:	20 s / 100 mm
Druh ochrany:	IP 50
Zásobování:	24 V DC / 0,5 A

(AC = Střídavý proud)

(DC = Stejnoseměrný proud)

Slovenská republika Pokyny/bezpečnostné upozornenie

- Dodržujte prosím návod.
- Dodržiavajte všeobecné bezpečnostné predpisy pre prácu na streche.
- Zabezpečte stavenisko proti prípadnému pádu dielcov. Rešpektujte stavebno-fyzikálne podklady týkajúce sa tepelnej izolácie, ochrany proti vlhkosti, vodotesnosti pri daždi a snežením a ochrany proti hluuku.
- Čísła vždy vyjadrujú postupnosť jednotlivých krokov montáže!
- Technické zmeny vyhradené.

 Zásahy do nosnej konštrukcie strechy môžu vykonávať len kvalifikovaní pracovníci!

V oblastiach so snežením sa musí nad okno namontovať prípravok na zachytávanie snehu.

Pomocné montážne laty musia byť z dreva bez uzlov a prasklín. Výška strešných lát a pomocných montážnych lát musí byť rovnaká!

Používajte len neupravené originálne diely ROTO.

Zabrňte deťom prístup do pracovného priestoru zariadenia.

Uložte ovládače mimo dosahu detí.

Dbajte na špecifické predpisy platné vo Vašej krajine.

Ak bude zariadenie ovládané jedným alebo viac ovládačmi, musí byť počas pohybu akčný rádius zariadenia opticky kontrolovateľný.

Technické údaje:

Riadiaci systém

Batérie pack:	12 V DC / min 2000 mAh
PV vstup:	12 V DC / 0,5 A
Menovité výstupné napätie M3:	12 V DC
Prípustný výstupný prúd M3:	max. 2,5 A
Menovité výstupné napätie M1, M2:	24 V DC
Prípustný výstupný prúd M1, M2:	á 0,5 A
Druh ochrany:	IP 20

Technické údaje:

Pohon

Tlaková sila (max.):	300 N
Ťažná sila (max.):	300 N
Doba chodu:	20 s / 100 mm
Druh ochrany:	IP 50
Elektrické napájanie:	24 V / 0,5 A

(AC = Striedavý prúd)

(DC = Jednosmerný prúd)

Magyar Köztársaság Utasítások/Biztonsági előírások

- Kérjük őrizze meg a használati útmutatót!
- A tetőfedő munkáknál figyelembe kell venni a balesetvédelmi előírásokat.
- Biztosítsák a beépítés helyszínét, hogy az esetlegesen lehulló hulladékok, illetve egyéb anyagok ne okozzanak balesetet.
- Vegyék figyelembe az épületfizikai alapokat, így a hőszigetelést, nedvességvédelmet, vízzáróságot és zajvédelmet.
- A számok mindig a szerelés sorrendjét mutatják.
- Műszaki változtatások jogát fenntartjuk.

 A tartószerkezetekhez csak képzett szakemberek nyúlhatnak hozzá!

Ahol gyakran havazik, az ablak felett hófogót kell felszerelni.

A lécezéshez csak csomó és repedésmentes fát szabad felhasználni. A tetőlécek és a segédlécek magassága megegyező legyen!

Használjon eredeti Roto alkatrészeket.

A gyermekeket tartsa távol a szerkezetek hatótávolságából.

Tartsa távol a gyermekeket a vezérléstől!

Kérjük vegye figyelembe az országára vonatkozó előírásokat!

Amennyiben a szerkezet egy vagy több vezérlőelemen keresztül működtethető, a szerkezet hatótávolságának jól beláthatónak kell lennie a működés során.

Műszaki adatok:

Vezérlés

Akkumulátor:	12 V DC / min 2000 mAh
PV bemenet:	12 V DC / 0,5 A
Névleges kimeneti feszültség M3:	12 V DC
Engedélyezett kimenő áramerősség M3:	max. 2,5 A
Névleges kimeneti feszültség M1, M2:	24 V DC
Engedélyezett kimenő áramerősség M1, M2:	egységenként 0,5 A
Védelmi osztály:	IP 20

Műszaki adatok:

Motor

Nyomóerő (max.):	300 N
Húzóerő (max.):	300 N
Futási idő:	20 s / 100 mm
Védelmi osztály:	IP 50
Áramellátás:	24 V DC / 0,5 A

(AC = váltóáram)

(DC = egyenáram)



Slovenija

Navodila

- Prosimo shranite navodila!
- Upoštevajte splošne predpise za varnost na strehi. Zavarujte gradbišče pred padajočimi deli s strehe.
- Upoštevajte gradbeno fizikalne osnove, kot so toplotna izolacija, zaščita pred vlago, varnost pred
- vdorom dežja/vode in zaščita pred hrupom.
- Številke vedno kažejo vrstni red vgradnje!
- Pridržujemo si pravico do
- tehničnih sprememb.

 Posege na nosilni konstrukciji smejo izvajati le kvalificirani strokovnjaki!

Na območjih s snežnimi padavinami je potrebno nad okno montirati snegolov.

Za vgradne letve uporabljajte le les vrste S 13. Višina strešnih letev in vgradnih letev mora biti enaka!

Uporabljajte le nespremenjene originalne Roto dele.

Otrokom preprečite dostop do področja odpiranja okna.

Otrokom preprečite dostop do upravljanja okna.

Upoštevajte veljavne varnostne predpise.

Področje odpiranja okna naj bo med upravljanjem v vašem vidnem polju.

Tehnični podatki:

Krmiljenje

Baterija pack:	12 V DC / min 2000 mAh
Vhod PV:	12 V DC / 0,5 A
Nazivna izhodna napetost M3:	12 V DC
Dovoljena izhodna električna energija M3:	max. 2,5 A
Nazivna izhodna napetost M1, M2:	24 V DC
Dovoljena izhodna električna energija M1, M2:	po 0,5 A
Vrsta zaščite:	IP 20

Tehnični podatki:

Pogon

Pritisna sila (maks.):	300 N
Vlečna sila (maks.):	300 N
Čas delovanja:	20 s / 100 mm
Vrsta zaščite:	IP 50
Napajanje:	24 V DC / 0,5 A

(AC = izmenični tok)

(DC = enosmerni tok)

(rel. H = relativna zračna vlažnost)

Italia

Consigli/Indicazioni di sicurezza

- Per favore tenere in considerazione le istruzioni.
- Durante i lavori sul tetto osservare le norme antinfortunistiche generali.
- Assicurare il luogo di lavoro contro la possibile caduta dei pezzi.
- Osservare i principi fondamentali fisici di costruzione quali l'isolamento termico, l'isolamento per l'umidità, la protezione contro l'acqua piovana/impermeabilità all'acqua, la protezione acustica.
- I numeri indicano sempre la sequenza di montaggio!
- Escluse modifiche tecniche.

 Gli interventi nelle strutture portanti devono essere eseguite solo dal personale specializzato!

In zone nevose si raccomanda di montare un sistema paraneve sopra alla finestra.

Per le assicelle di montaggio utilizzare solo legno senza nodi ed incrinature. Le altezze dei listoni del tetto e le altezze delle assicelle di montaggio devono essere uguali!

Per favore utilizzare solamente accessori Roto originali e integri.

Tenere lontano i bambini dal campo di utilizzo dell'impianto.

Tenere lontano i bambini dalle centraline.

Considerare le direttive specifiche della Vs. nazione.

Se l'impianto sarà pilotato attraverso elementi singoli o plurimi, durante l'utilizzo, il campo di pericolo dell'impianto deve essere ben visibile.

Dati tecnici:

Controllore

Battery Pack/Batteria:	12 V DC / min 2000 mAh
Ingresso PV:	12 V DC / 0,5 A
Valore tensione in uscita M3:	12 V DC
Corrente permessa in uscita M3:	max. 2,5 A
Valore tensione in uscita M1, M2:	24 V DC
Corrente permessa in uscita M1, M2:	je 0,5 A
Modo di protezione:	IP 20

Dati tecnici:

Azionamento

Forza di compressione (max.):	300 N
Forza di trazione (max.):	300 N
Durata:	20 s / 100 mm
Modo di protezione:	IP 50
Alimentazione:	24 V DC / 0,5 A

(AC = Tensione alternata/di scambio)

(DC = Tensione continua)

(Rel. H = relativa umidità atmosferica)

Hrvatska/Bosna i Hercegovina Napomene/sigurnosne napomene

- Molimo sačuvajte uputstva.
- Pridržavajte se općih propisa sigurnosti za radove na krovu.
- Osigurajte gradilište od dijelova koji mogu pasti s krova.
- Pridržavajte se građevinsko fizikalnih osnova kao što su toplinska izolacija, zaštita od vlage, sigurnost od prodora kiše/brtvljenje i zaštita od buke.
- Brojevi označavaju redosljed kod montaže!
- Pridržano pravo tehničkih izmjena.

 Radove na nosivim konstrukcijama smiju izvoditi samo kvalificirani stručnjaci!

U krajevima gdje pada snijeg treba iznad prozora montirati uređaj za zaštitu od snijega.

Za ugradbene letve upotrebljavajte samo drvo 1. klase. Visina krovnih letava i visina ugradbenih letava mora biti jednaka!

Upotrebljavajte samo neizmijenjene Roto originalne dijelove.

Držite djecu podalje od radnog područja motora.

Držite djecu podalje od upravljačkog sistema.

Pridržavajte se važećih odredbi.

Ukoliko se uređajem upravlja jednim ili više elemenata za upravljanje, radno područje uređaja za vrijeme rada mora biti vidljivo.

Tehnički podaci:

Upravljanje

Baterija:	12 V DC / min 2000 mAh
PV ulaz:	12 V DC / 0,5 A
Nazivni izlazni napon M3:	12 V DC
Dopuštena izlazna struja M3:	max. 2,5 A
Nazivni izlazni napon M1, M2:	24 V DC
Dopuštena izlazna struja M1, M2:	je 0,5 A
Vrsta zaštite:	IP 20

Tehnički podaci:

Pogon

Sila pritiska (maks.):	300 N
Vučna sila (maks.):	300 N
Vrijeme rada:	20 s / 100 mm
Vrsta zaštite:	IP 50
Napajanje:	24 V DC / 0,5 A

(AC= Izmjenična struja)

(DC= Istosmjerna struja)

(rel. H= relativna vlažnost zraka)

Romania Măsuri de siguranță

- Vă rugăm să păstrați instrucțiunile!
- Respectați măsurile de siguranță valabile pentru lucrările pe acoperiș.
- Asigurați șantierul contra căderii oricăror obiecte de pe acoperiș.
- Respectați regulile impuse de fizica acoperișului cum ar fi : termoizolația, hidroizolația, protecția contra precipitațiilor, protecția contra umezelii și protecția fonică.
- Numerele reprezintă întotdeauna ordinea!
- Ne rezervăm dreptul a face schimbări din punct de vedere tehnic.

 Lucrările legate de structura de bază/siguranță efectuate la acoperiș se execută numai de către personalul calificat.

În țările cu zăpadă, deasupra ferestrei se va monta un dispozitiv de captare a zăpezii.

Pentru stinghiile de fixare a se folosi numai lemn calitatea I . Înălțimea stinghiilor și al caroiajului trebuie să fie egală.

Folosiți numai piese originale, nemodificate, de la Roto.

Nu atingeți părțile mobile atât timp cât sunt în mișcare.

Nu lăsați telecomenzile la îndemâna copiilor !

Respectați reglementările în vigoare specifice fiecărei țări în parte.

Atunci când se acționează unul sau mai multe motoare, mișcarea acestora trebuie să poată fi controlată vizual.

Date tehnice :

Comanda

Accumulator:	12 V DC / min 2000 mAh
Intrare PV:	12 V DC / 0,5 A
Tensiune de lucru M3:	12 V DC
Intensitate curent M3:	max. 2,5 A
Tensiune de lucru M1, M2:	24 V DC
Intensitate curent M1, M2:	cate 0,5 A fiecare
Clasa de protecție:	IP 20

Date tehnice :

Acționarea

Forța de presiune (max.):	300 N
Forța de tracțiune (max.):	300 N
Perioada de funcționare:	20 s / 100 mm
Clasa de protecție:	IP 50
Alimentarea:	24 V DC / 0,5 A

(AC = Curent alternativ)

(DC = curent continuu)



■ Greece

Συμβουλή/σύσταση ασφάλειας

- Παρακαλώ κρατήστε τις οδηγίες τοποθέτησης
- Τηρήστε τα γενικά προληπτικά μέτρα ασφαλείας για τις εργασίες σε οροφές κτιρίων.
- Ασφαλίστε το εργοτάξιο από τυχόν πτώση αντικειμένων.
- Λάβετε υπόψη τις βασικές φυσικές κατασκευαστικές αρχές, όπως η θερμομόνωση, η προστασία από την υγρασία, η προστασία από τη βροχή/ η υδατοστεγανότητα και η αντιθρομβική προστασία.
- Οι αριθμοί αντιστοιχούν πάντα στη σωστή σειρά τοποθέτησης!
- Με την επιφύλαξη τροποποιήσεων.

⚠ Οι επεμβάσεις στη φέρουσα κατασκευή επιτρέπεται να πραγματοποιούνται αποκλειστικά από εξειδικευμένο προσωπικό!

Στις περιοχές με χιονοπτώσεις πρέπει να τοποθετηθεί πάνω από το παράθυρο μια διάταξη συγκράτησης του χιονιού.

Για τις δοκούς τοποθέτησης χρησιμοποιήστε αποκλειστικά ξύλο της κατηγορίας ταξινόμησης S 13. Το ύψος των δοκών της οροφής και το ύψος των δοκών τοποθέτησης πρέπει να είναι το ίδιο!

Χρησιμοποιήστε μόνο γνήσια Roto εξαρτήματα.

Παρακαλώ παραμείνετε μακριά από το πεδίο κίνησης του παραθύρου.

Παρακαλώ κρατήστε τα παιδιά μακριά από τα χειριστήρια.

Προσέξτε τους κανονισμούς της χώρας σας.

Αν έχετε έναν ή περισσότερους κινητήρες θα πρέπει να προσέξετε, κατά την κίνηση τους να είναι εμφανές το πεδίο κίνησης.

Τεχνικά χαρακτηριστικά

Μονάδα ελέγχου

Battery Pack/μπαταρία:	12 V DC / min 2000 mAh
φωτοβολταϊκής εισόδου:	12 V DC / 0,5 A
Ονομαστική τάση εξόδου M3:	12 V DC
Επιτρεπτό ρεύμα εξόδου M3:	max. 2,5 A
Ονομαστική τάση εξόδου M1, M2:	24 V DC
Επιτρεπτό ρεύμα εξόδου M1, M2:	από 0,5 A
Βαθμός προστασίας:	IP 20

Τεχνικά χαρακτηριστικά

Κινητήρας

Δύναμη πίεσης (μέγ.):	300 N
Δύναμη εφελκισμού (μέγ.):	300 N
Χρόνος λειτουργίας:	20 s / 100 mm
Βαθμός προστασίας:	IP 50
Τροφοδοσία:	24 V DC / 0,5 A

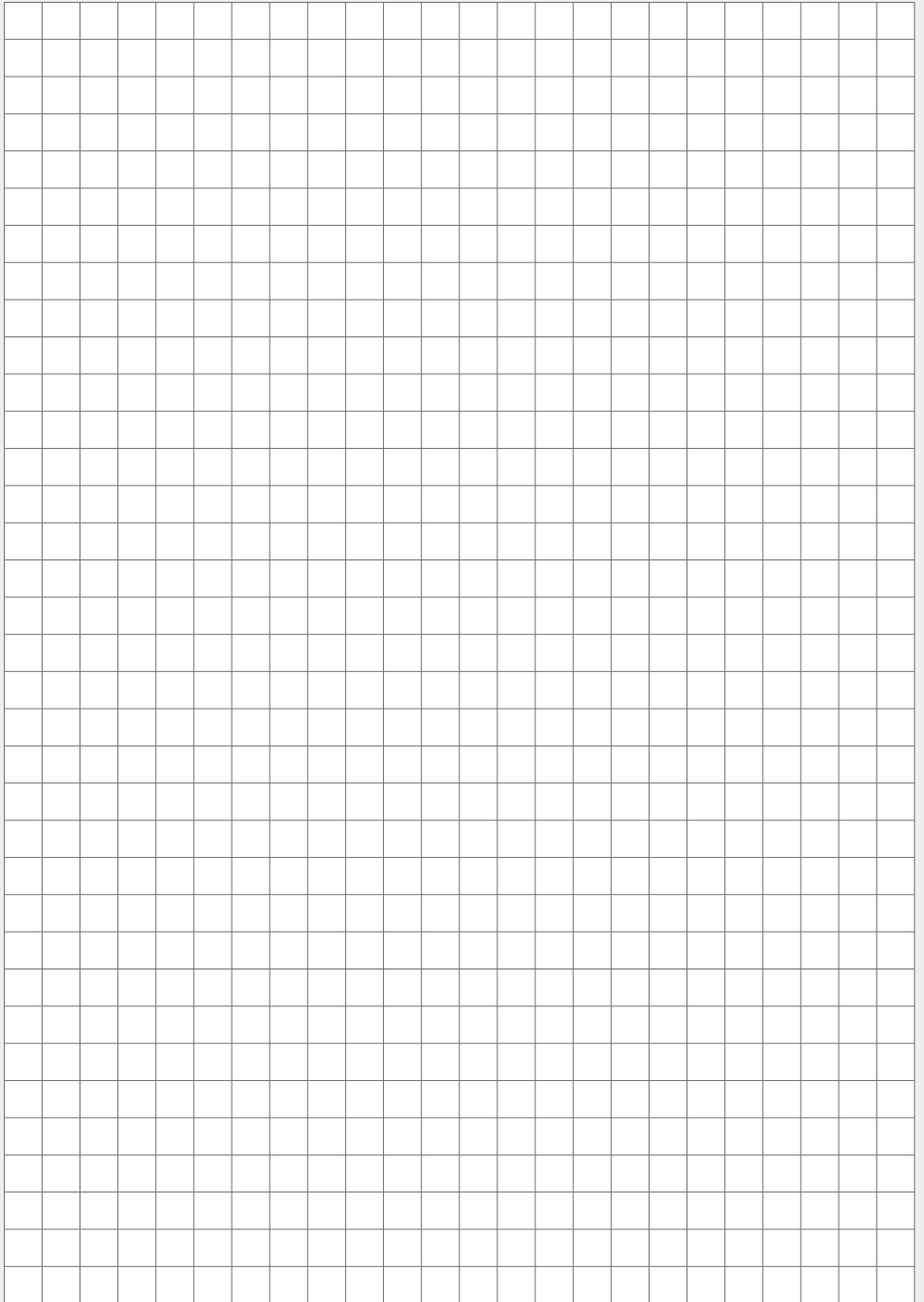

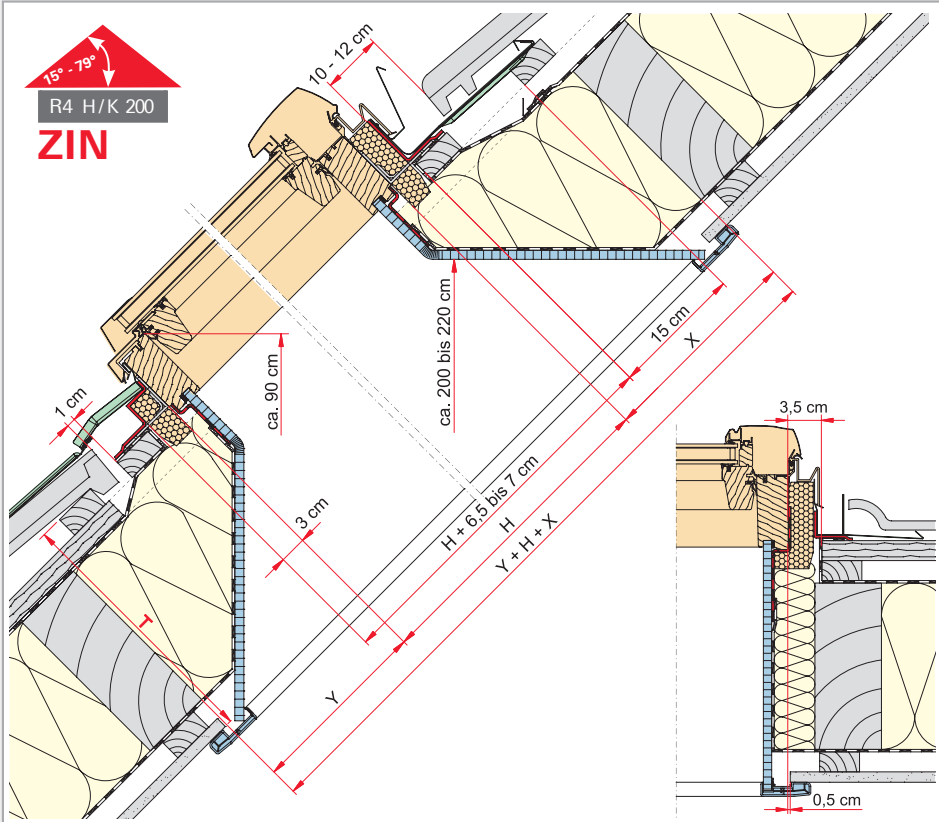

ZIN ▲		20°	25°	30°	35°	40°	45°	50°	55°	60°	65°	70°
T=26 cm	X	48	38	31	25	21	18	15	13	11	9	7
	Y	7	9	11	13	15	18	21	25	31	38	48
T = 28 cm	X	54	42	34	28	24	20	17	14	12	10	8
	Y	8	10	12	14	17	20	24	28	34	42	54
T = 30 cm	X	59	46	38	31	26	22	18	15	13	10	8
	Y	8	10	13	15	18	22	26	31	38	46	59
T = 32 cm	X	65	51	41	34	28	24	20	17	14	11	8
	Y	9	11	14	17	20	24	28	34	41	51	65
T = 36 cm	X	76	59	48	40	33	28	23	20	16	13	10
	Y	10	13	16	20	23	28	33	40	48	59	76
T = 40 cm	X	87	68	55	45	38	32	27	22	19	15	12
	Y	12	15	19	22	27	32	38	45	55	68	87



	A ø4,0 x30	B 4mm 2mm	C ø4,0 x20	D ø3,9 x19	E	F	G	H RS	I
R4 K 100	16	2	2		2		8		
R4 K 100 xx/ 9, xx/11 xx/14	16	2	2	4	2	2	8		
R4 K 200	16	2	2		2				
R4 K 200 xx/ 9, xx/11 xx/14	16	2	2		2				
SF								1	1

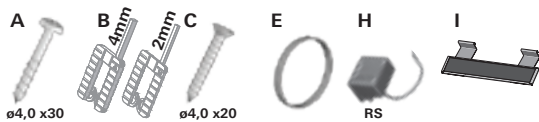



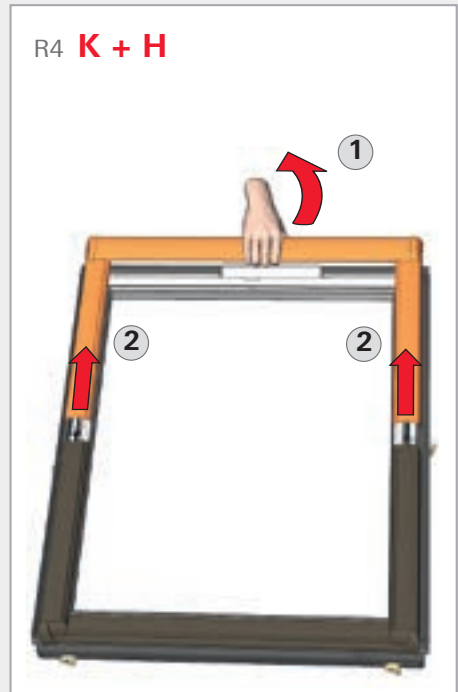
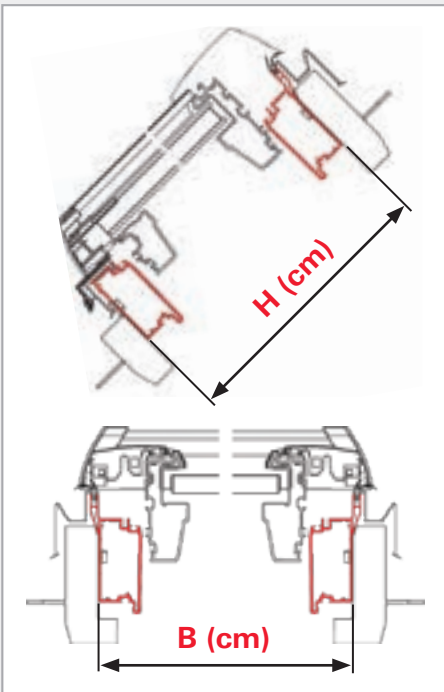
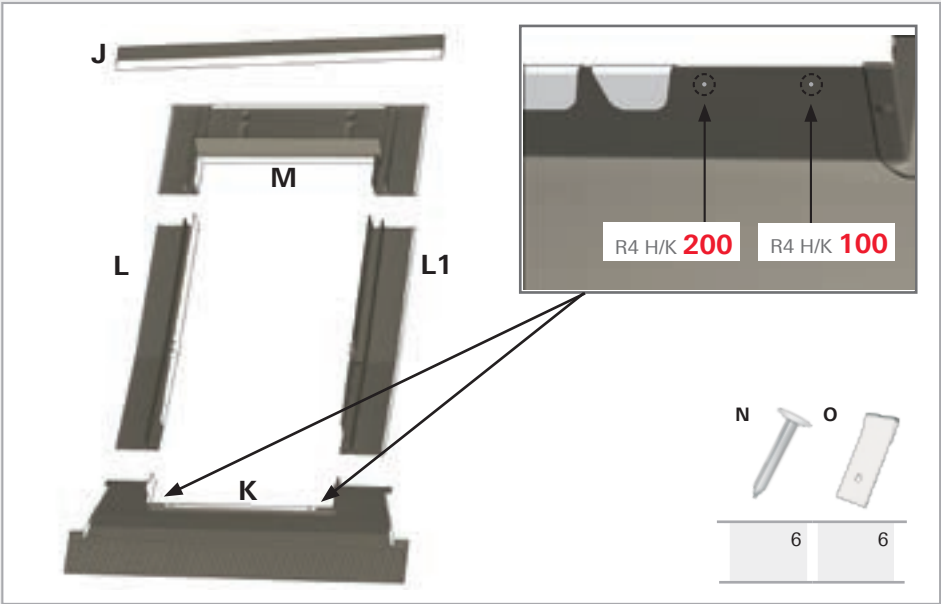

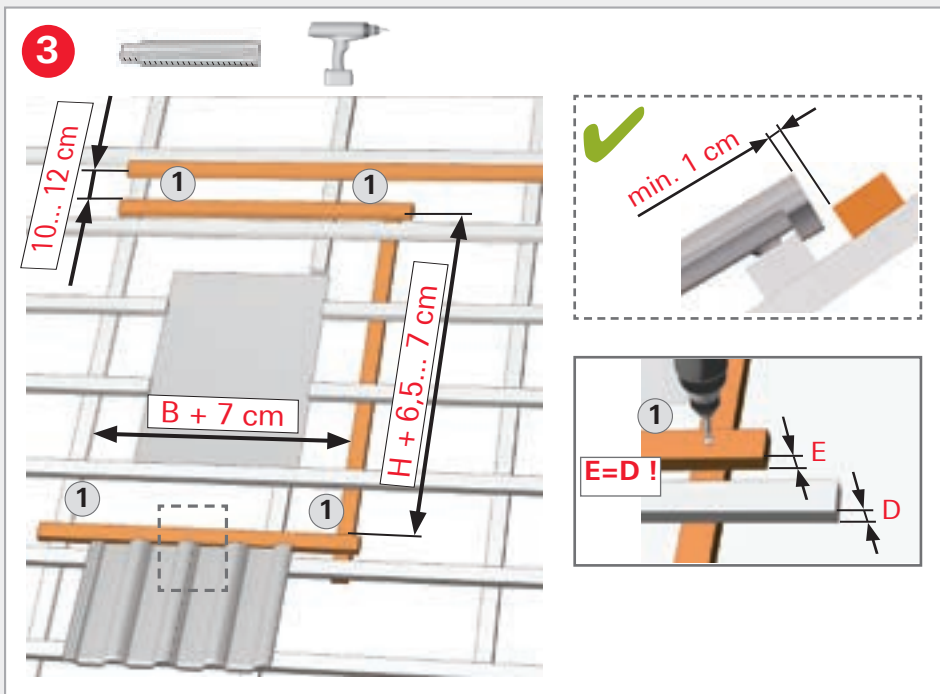
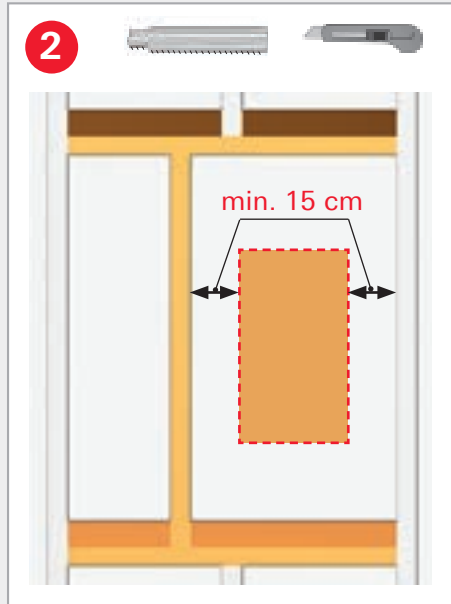
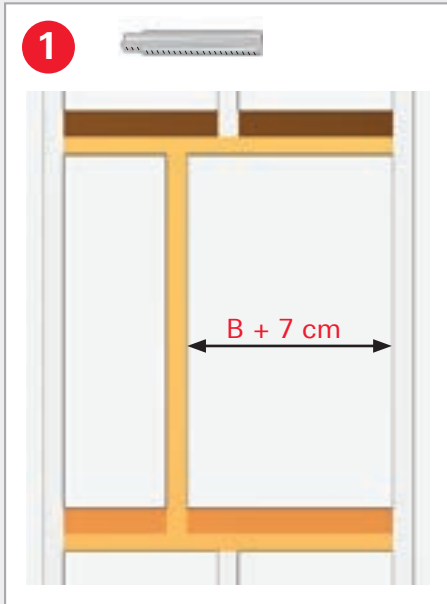
	A	B	C	E	H	I
R4 H 100	10	1	2	2		
R4 H 200	10	1	2	2		
SF					1	1

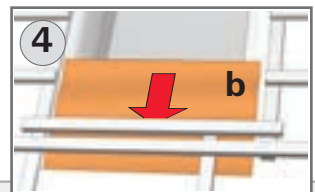
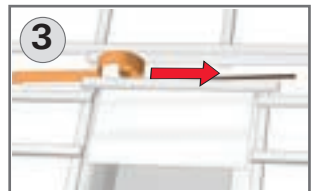
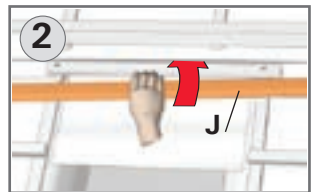
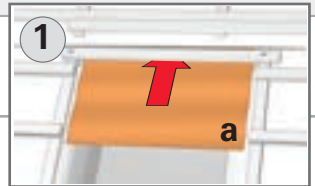
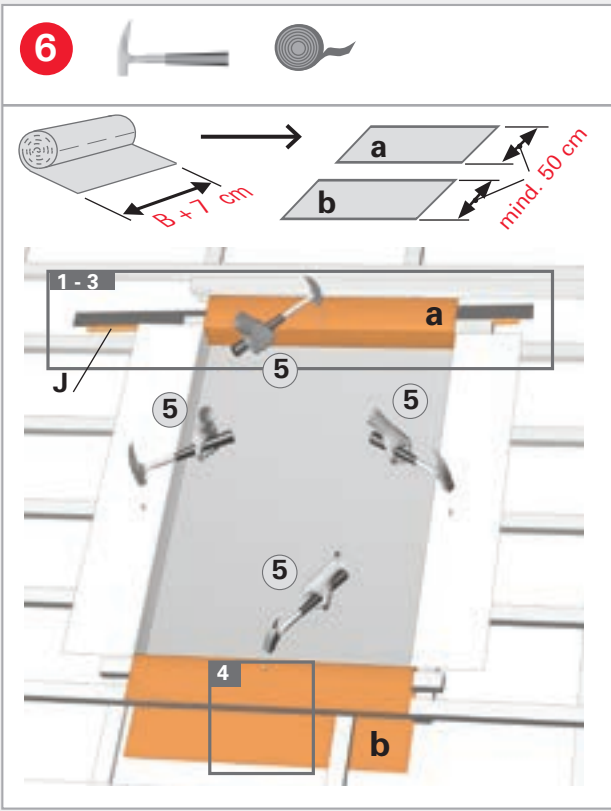
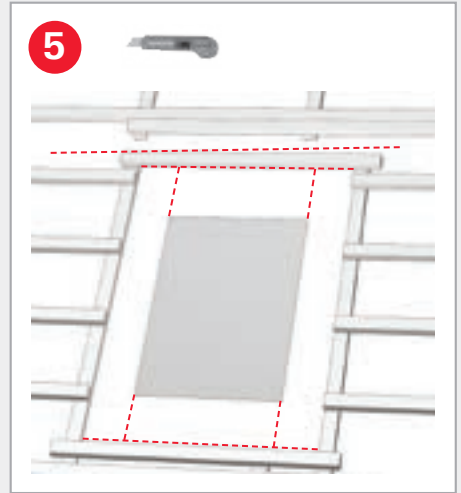
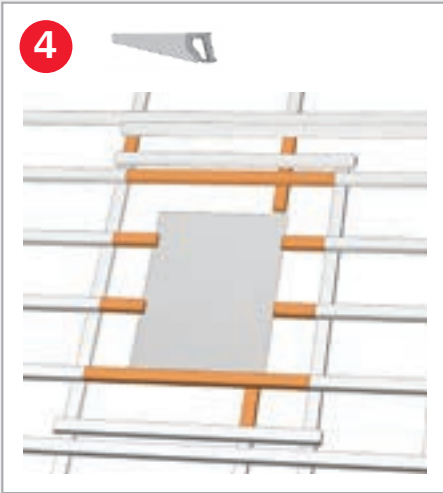





		R4 K	20
---	---	-------------------	-----------

		R4 H	26
---	---	-------------------	-----------

		R4 K + H	32
---	---	-----------------------	-----------

R4 **K** xx/ 9, xx/11, xx/14

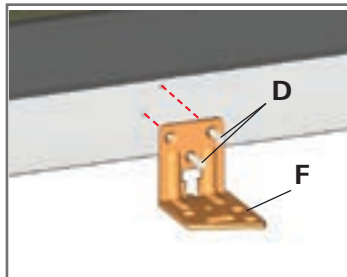

1

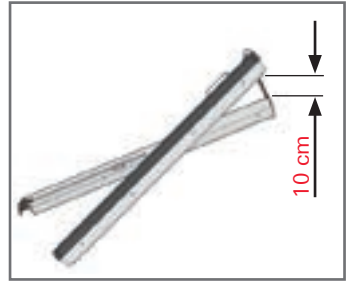
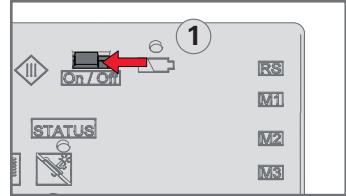
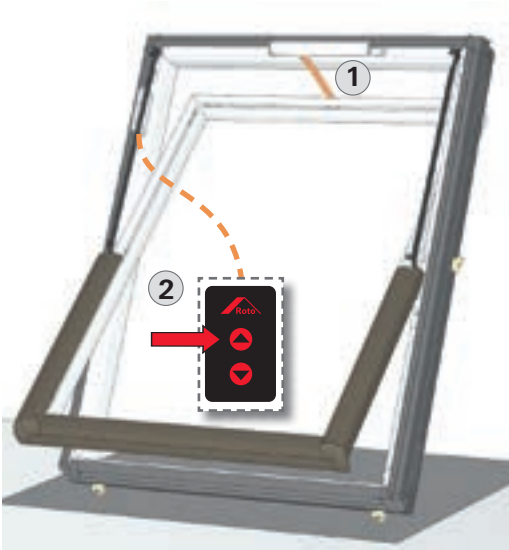

2

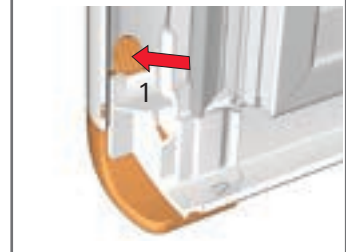
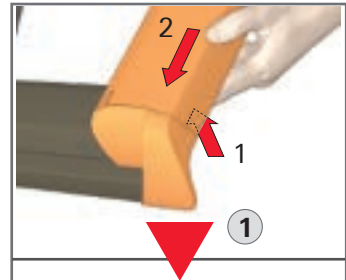
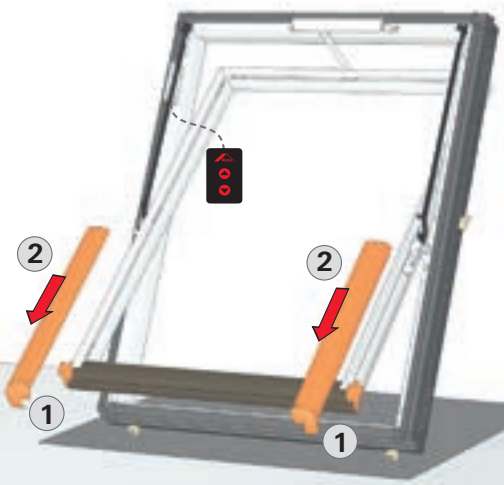

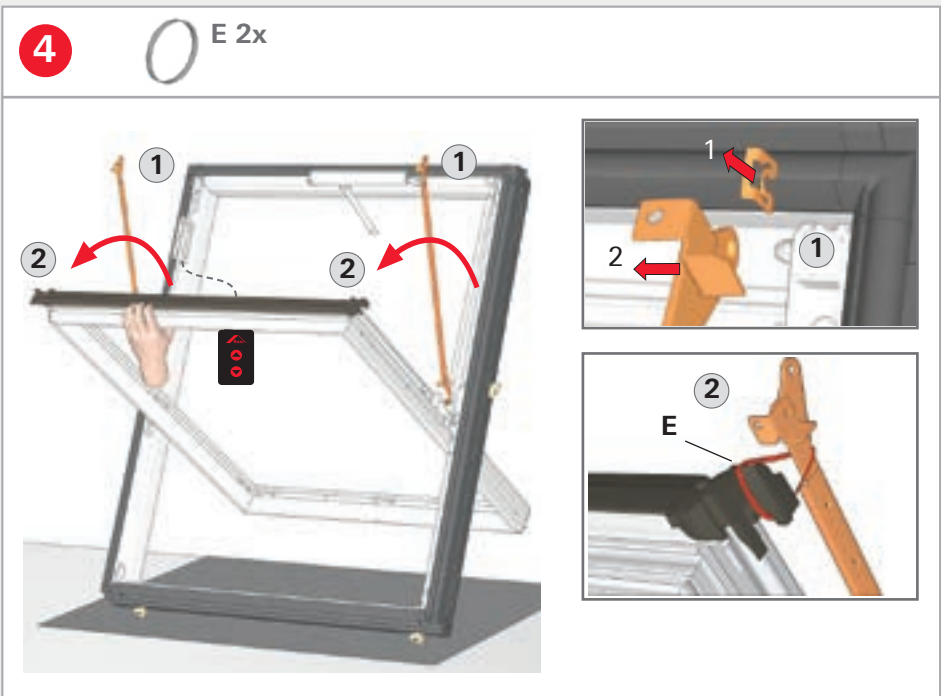
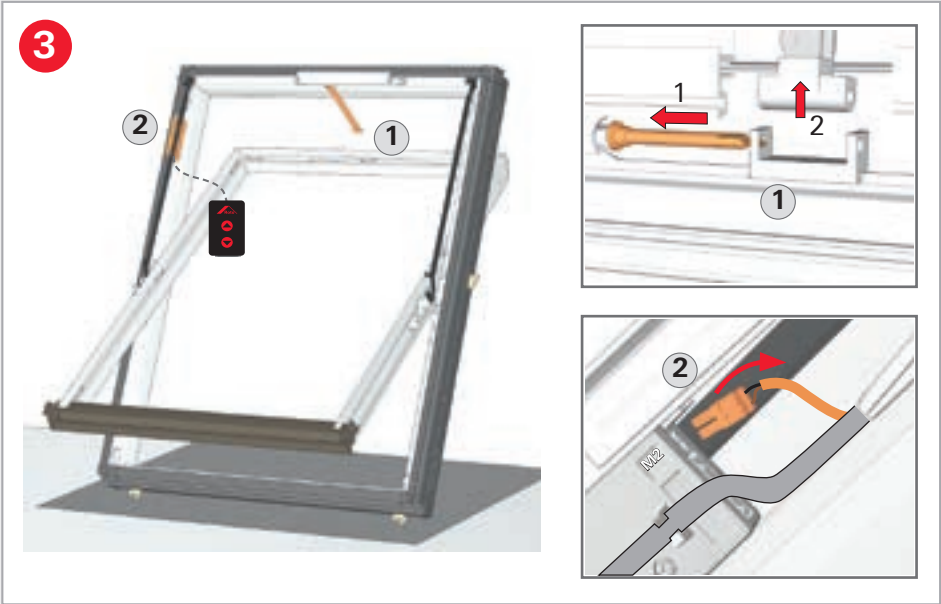

5



6

P



7

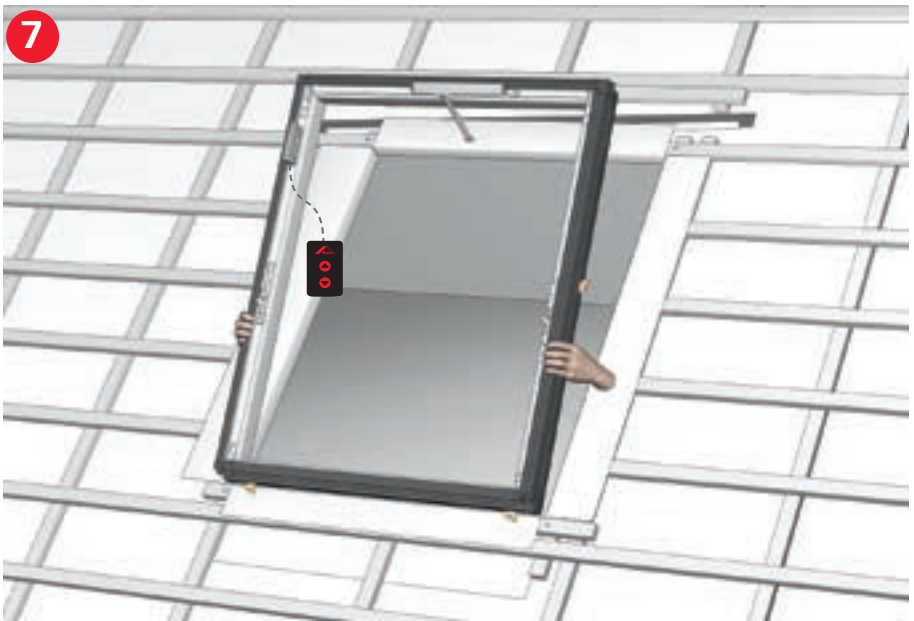

8

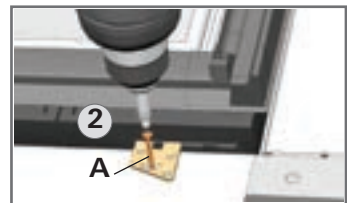
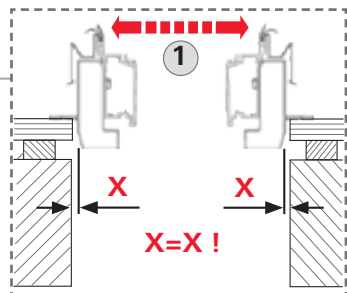
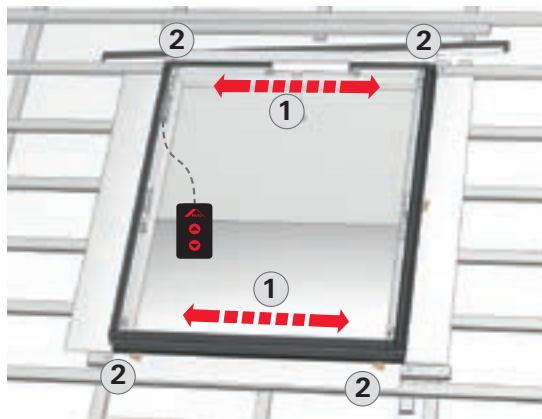

9

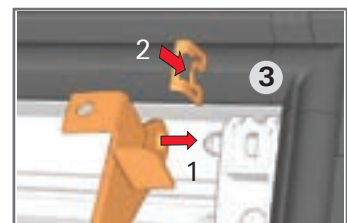
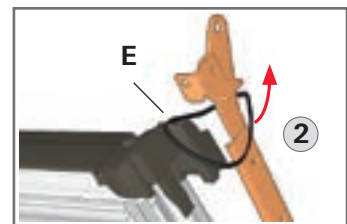
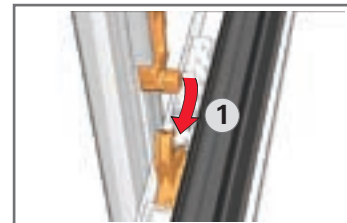
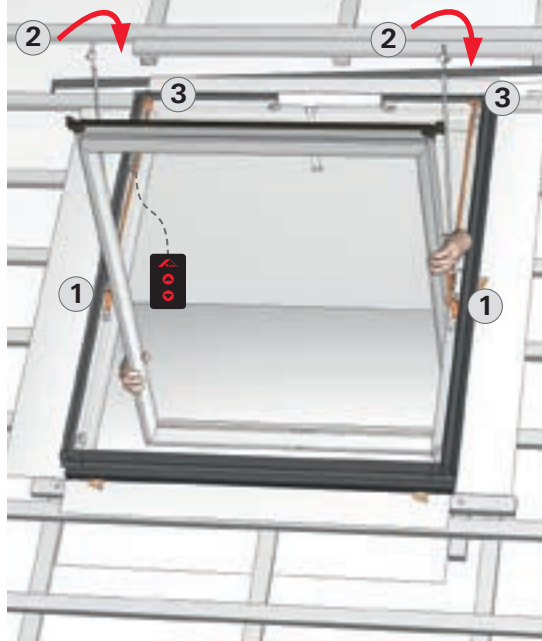

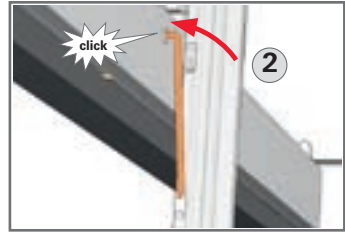
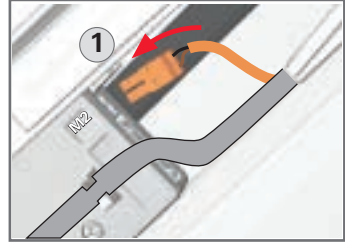
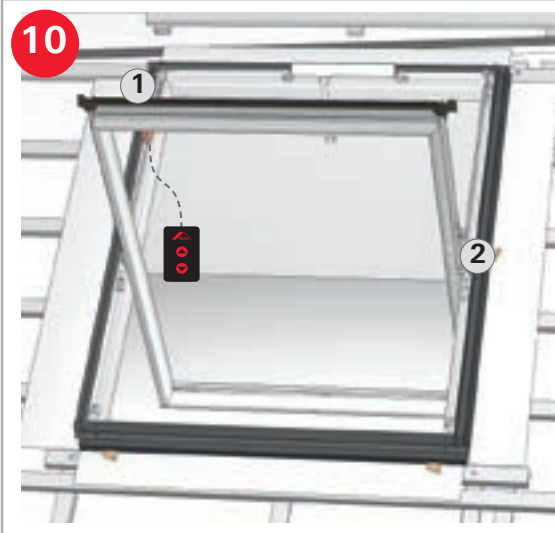

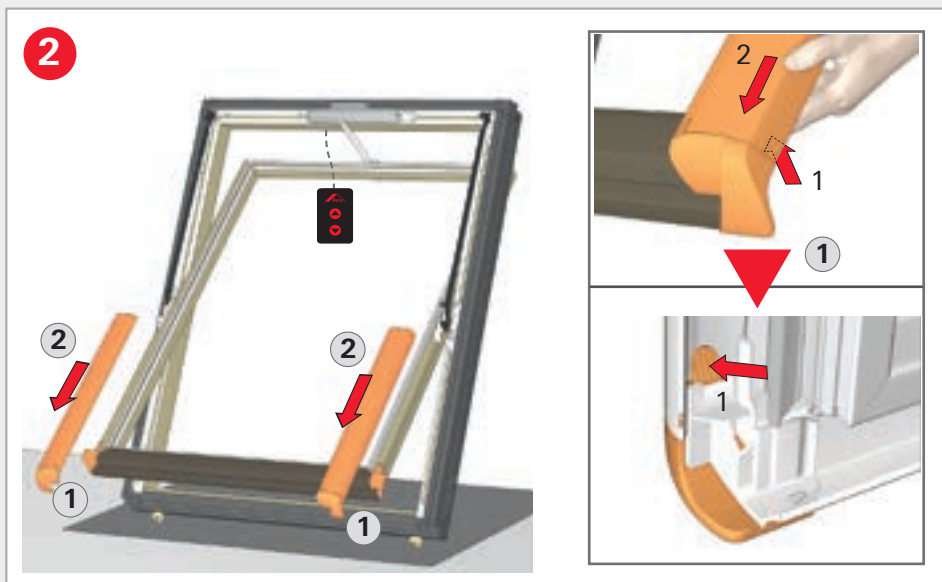
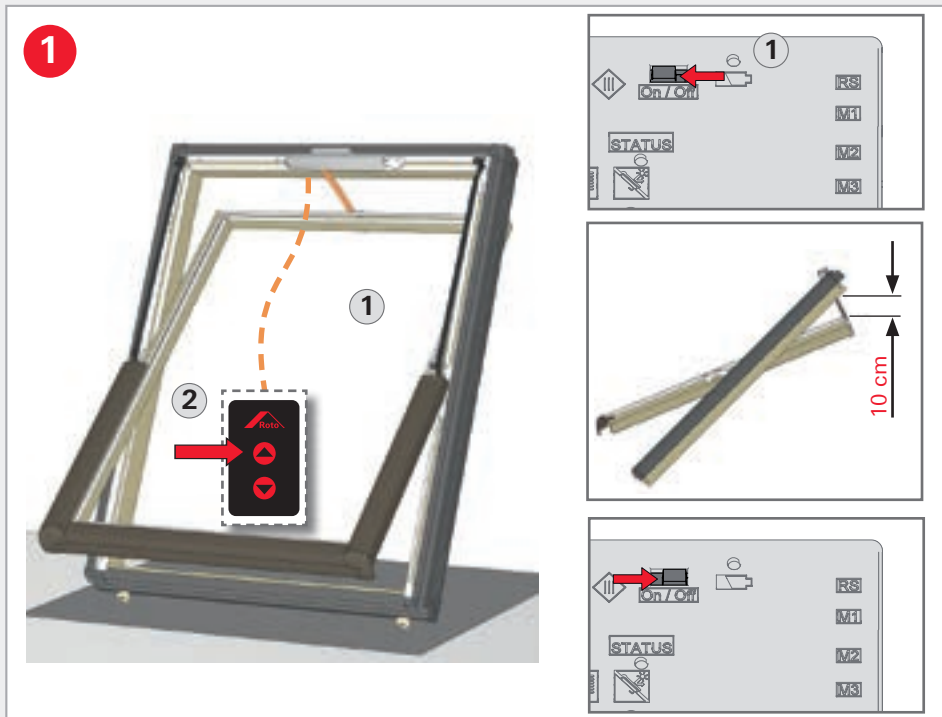

3

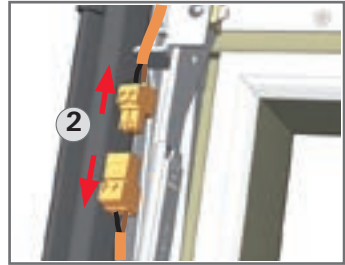
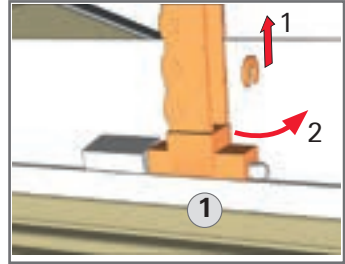
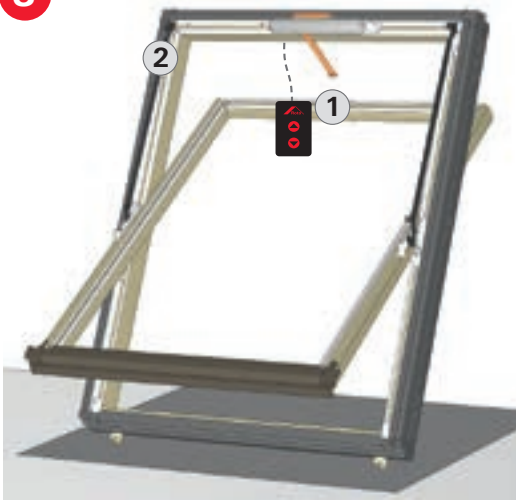

4

 E 2x

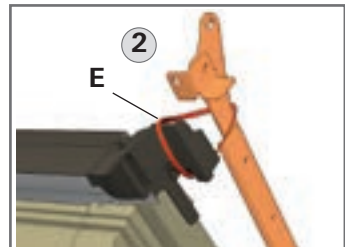
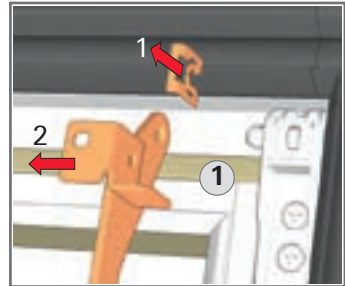
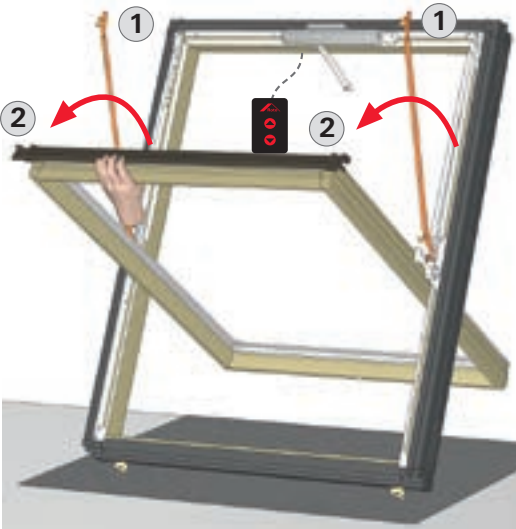

5

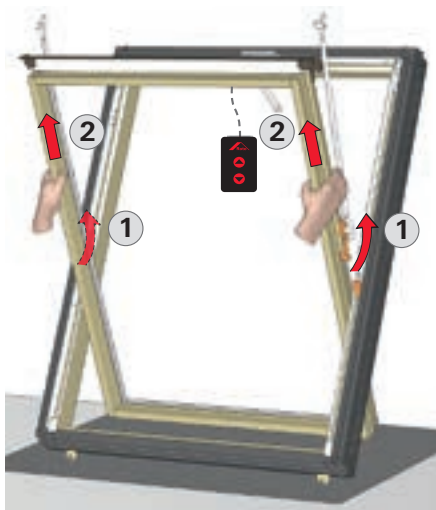

6

P



7

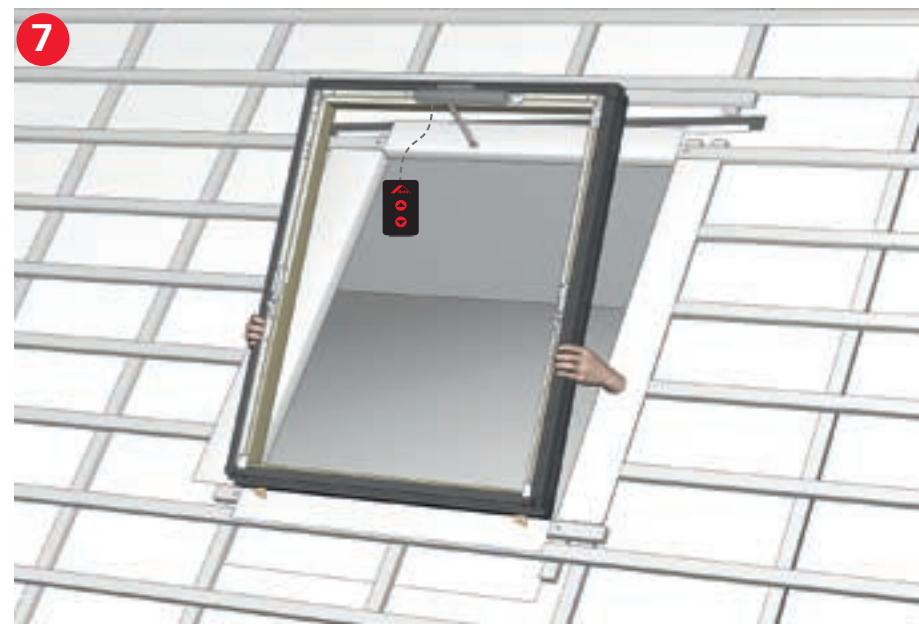

8



A 4x
ø4,0 x30

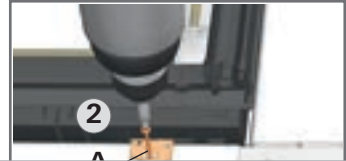
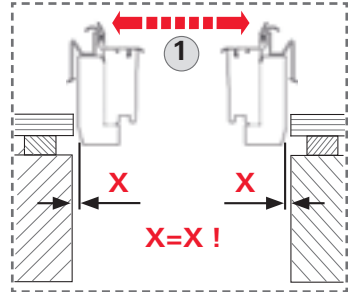
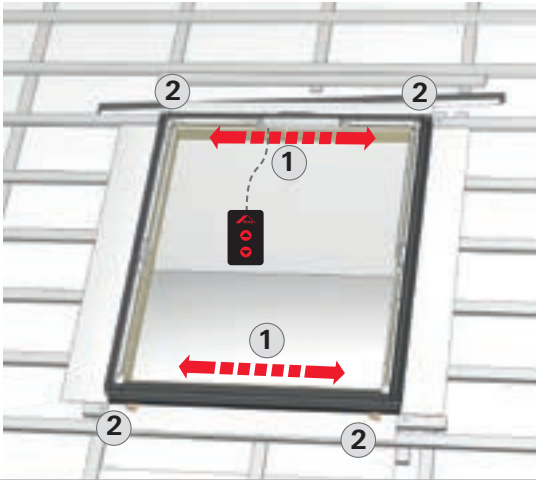

9

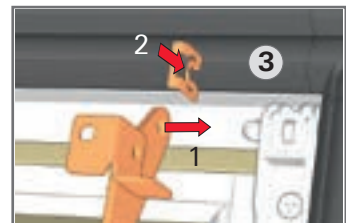
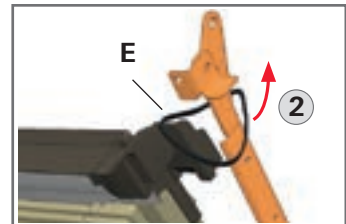
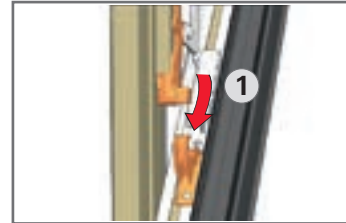
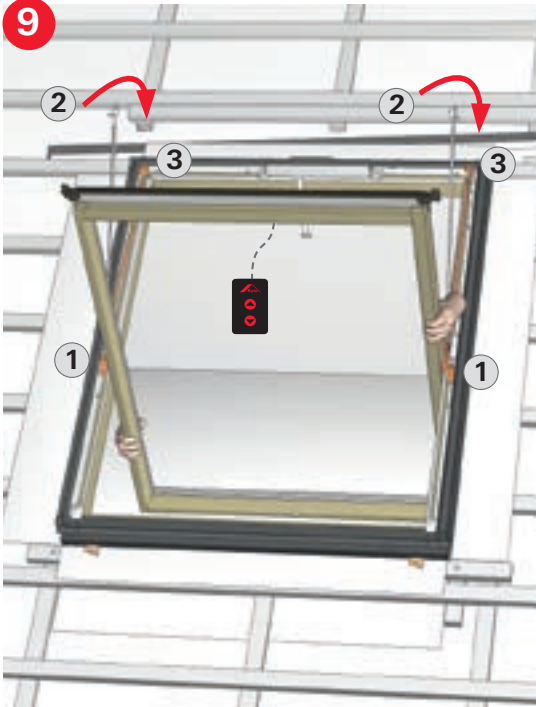

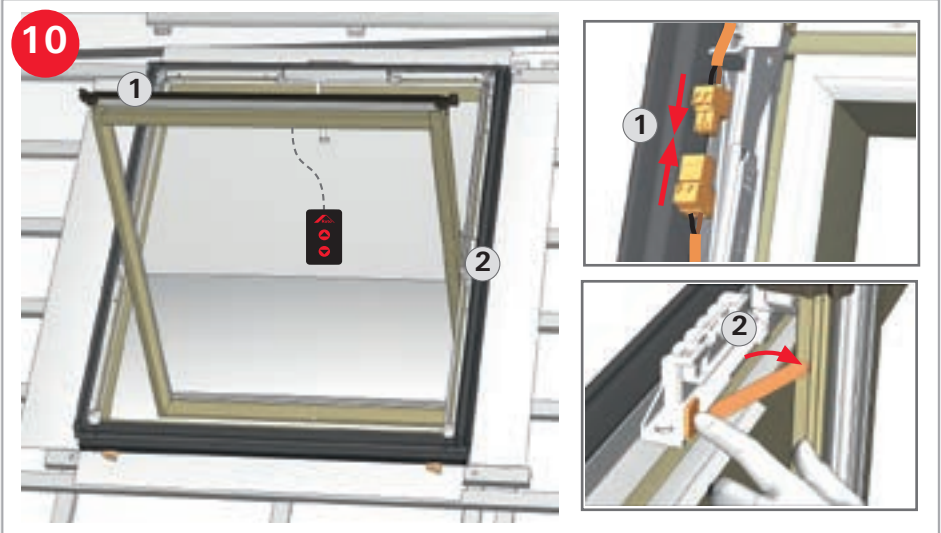

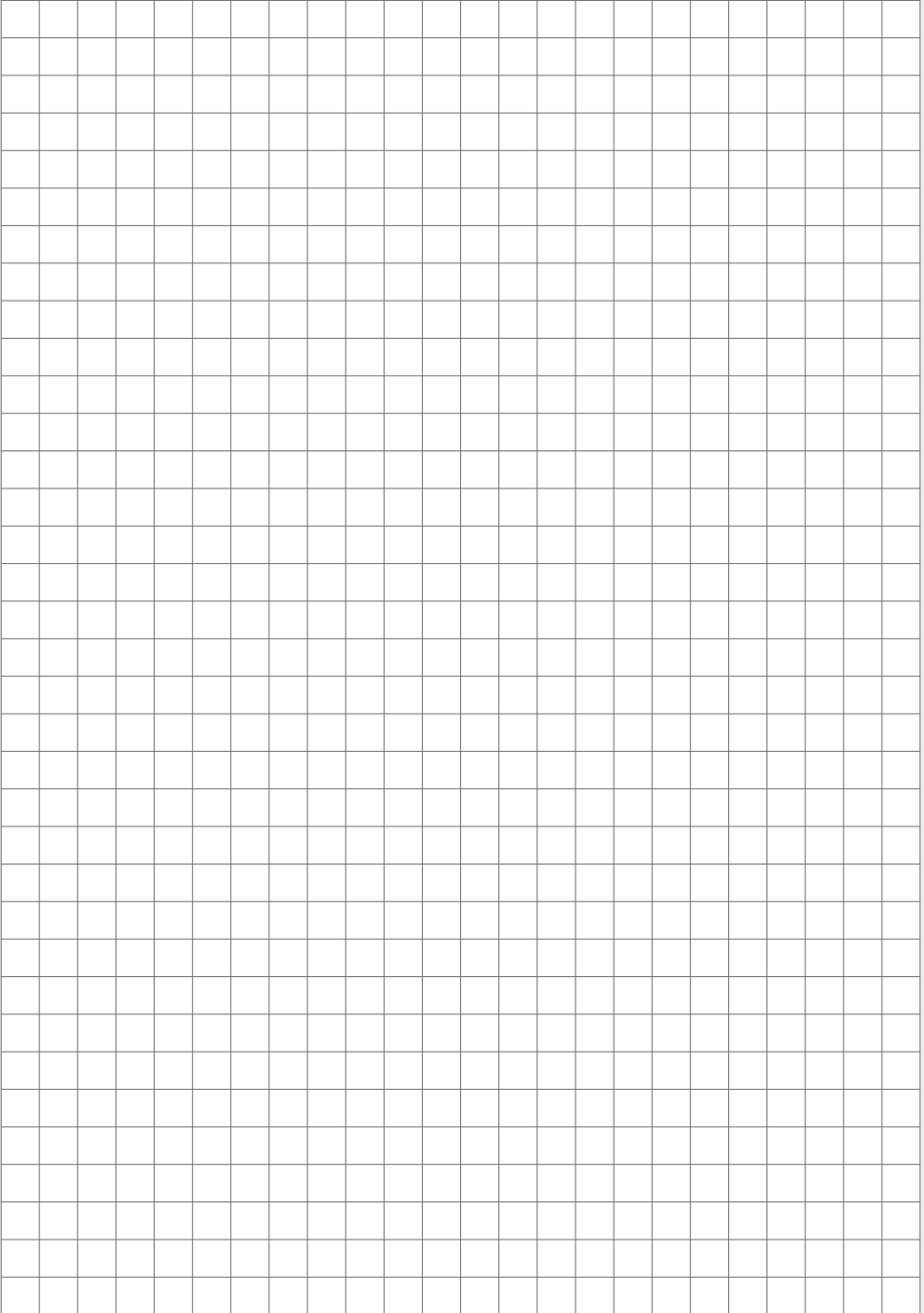

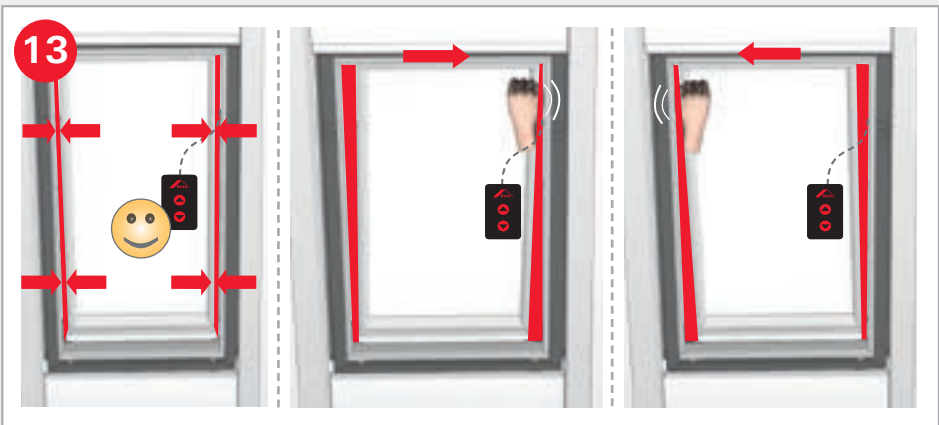
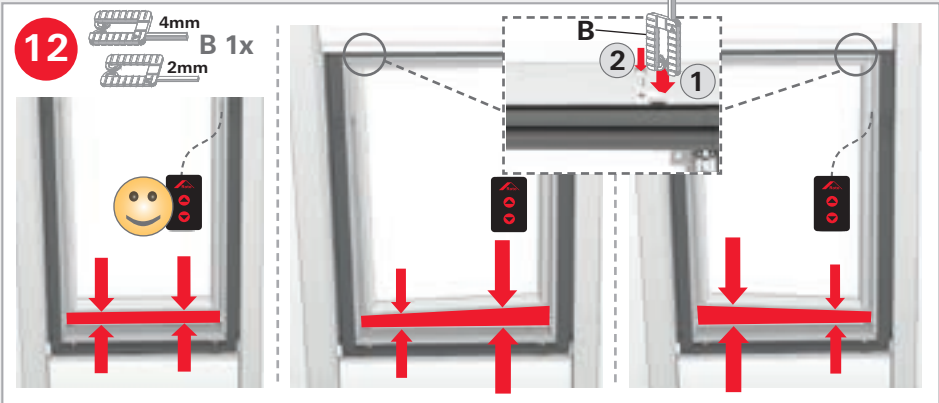
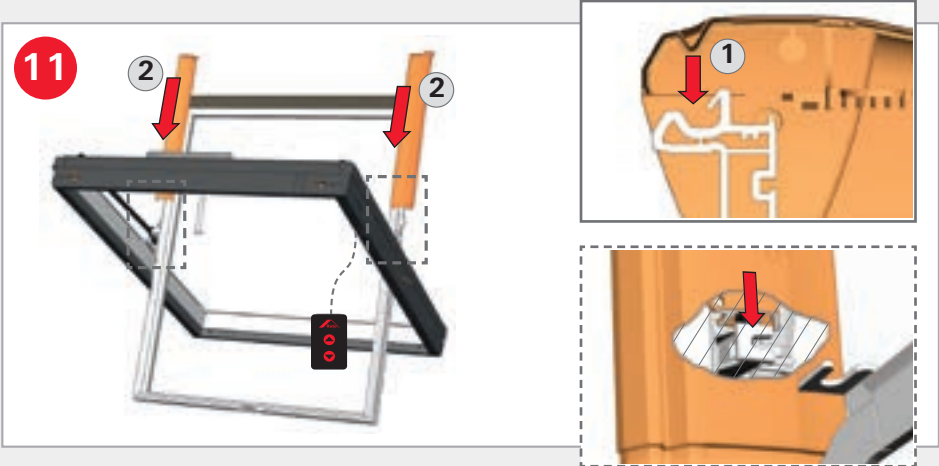

14



A 4x
ø4,0 x30

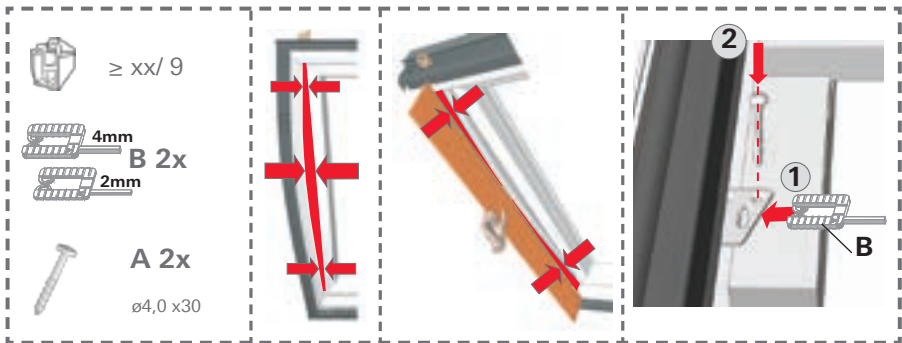
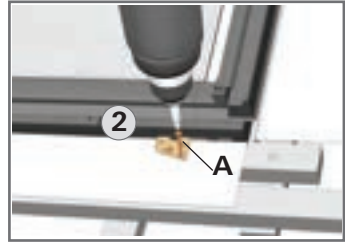
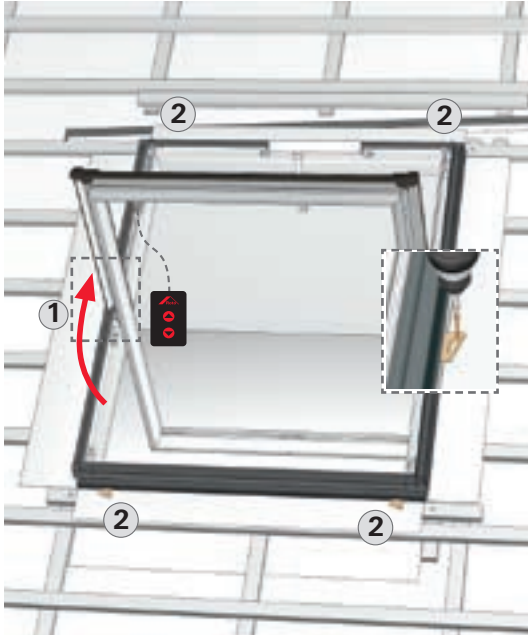

15

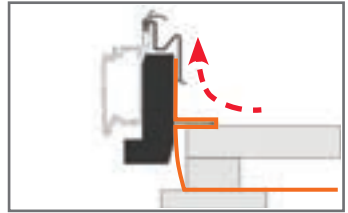
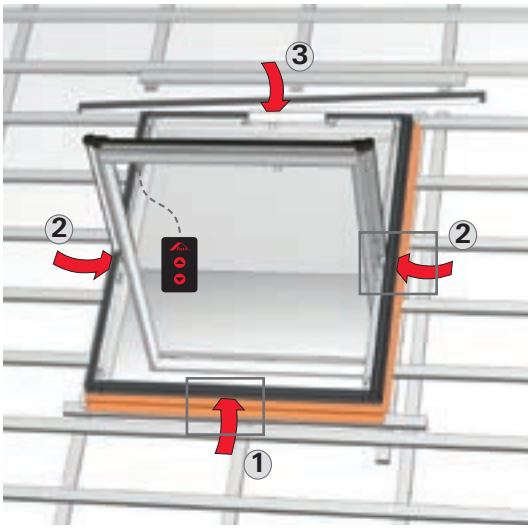

16

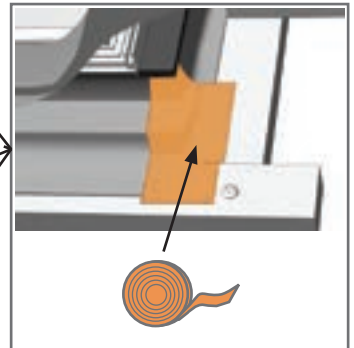

17



C 2x

ø4,0 x20

R4 K/ H **200**

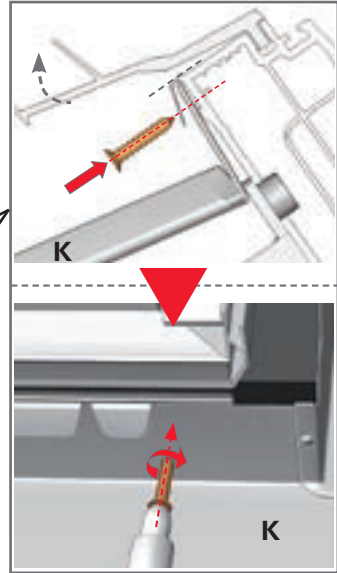
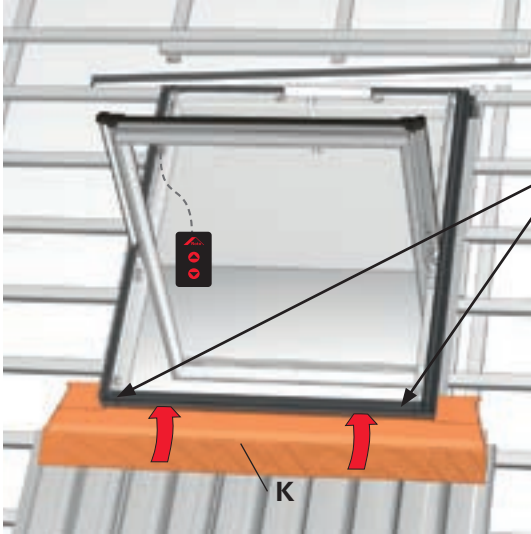

R4 K/ H **100**

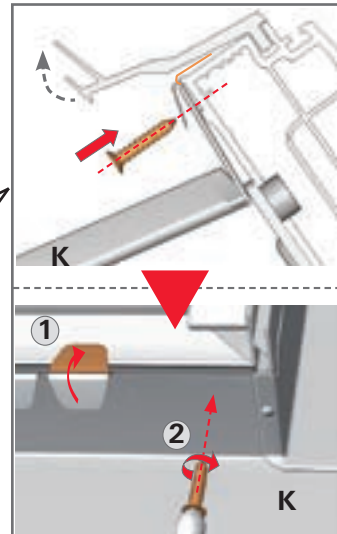
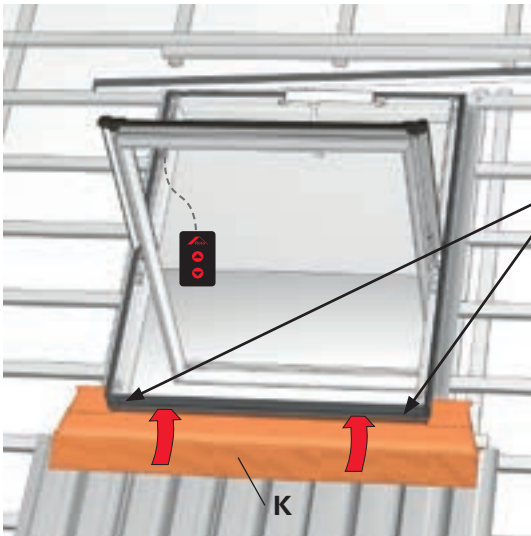

18



H 1x

R4 **K**

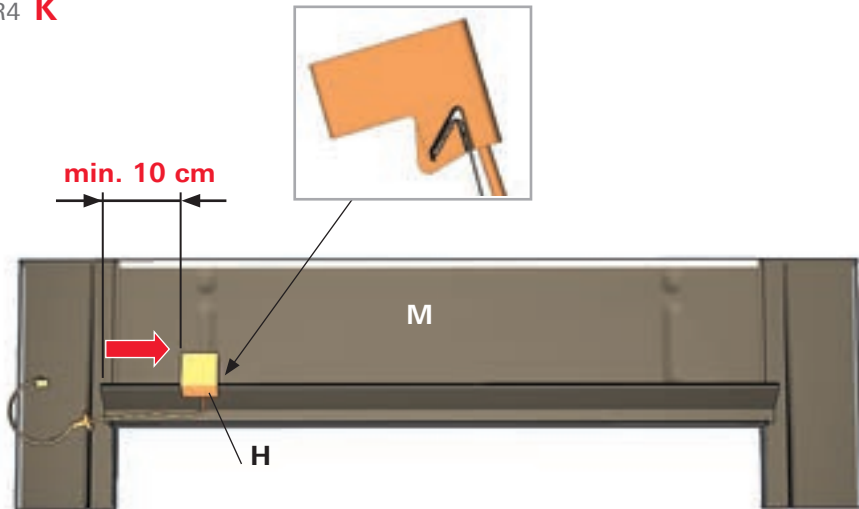

R4 **H**

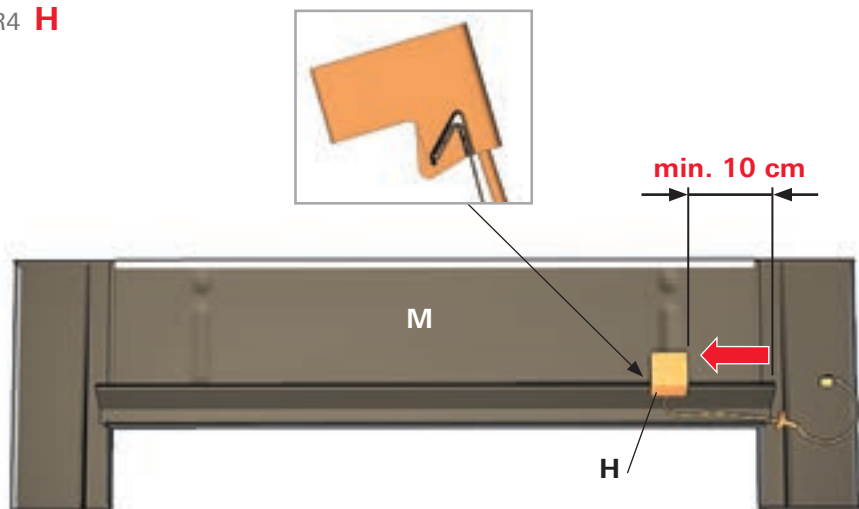

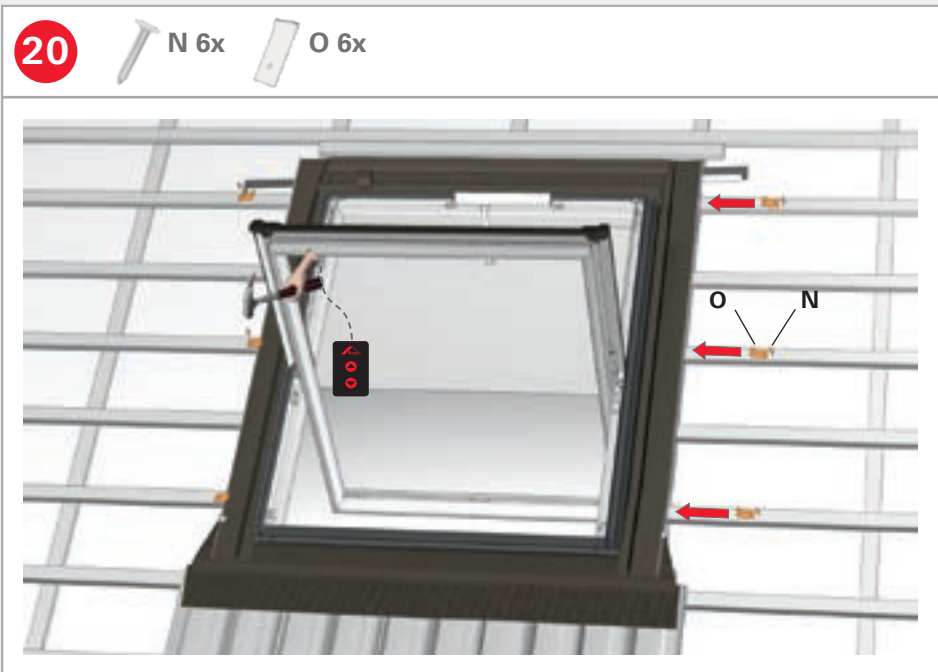
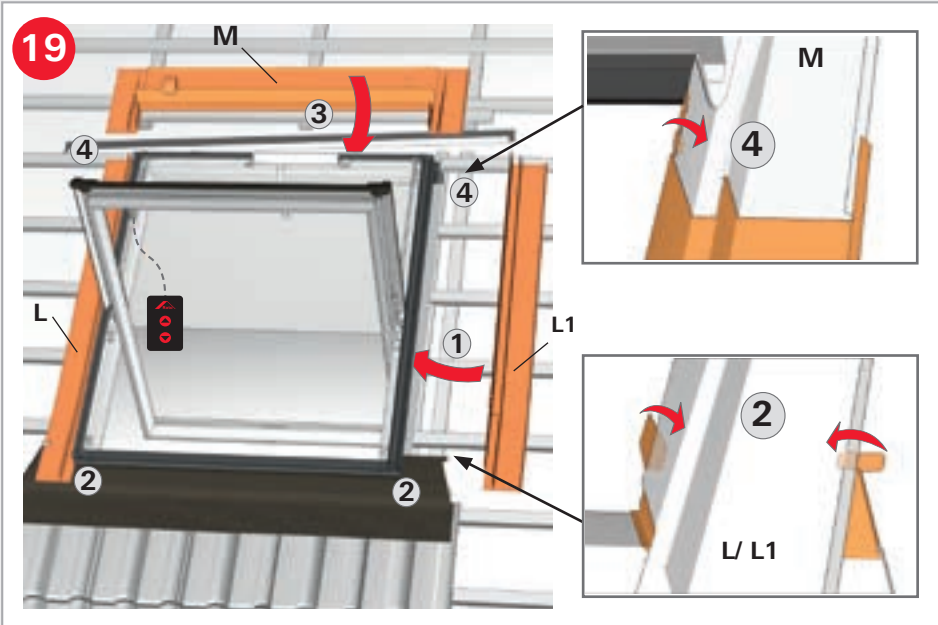

21 R4 **K**

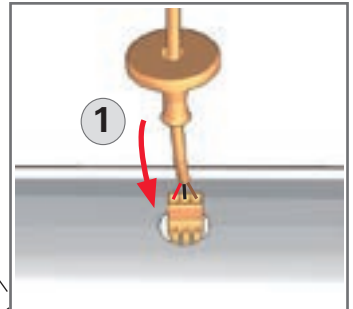
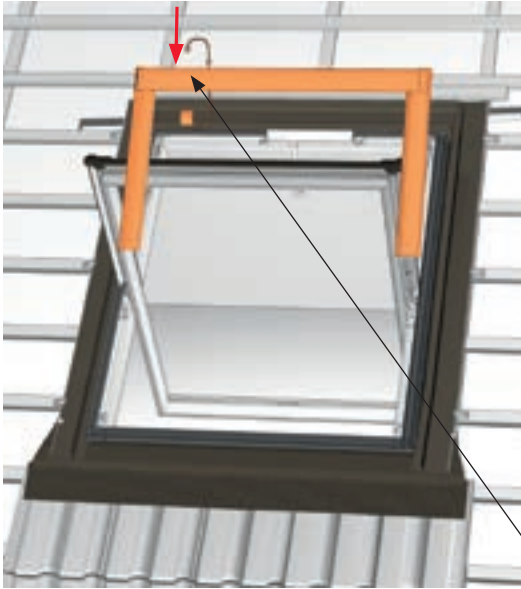

R4 **H**

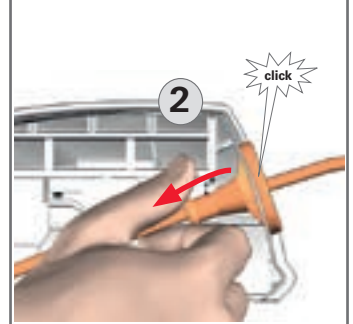
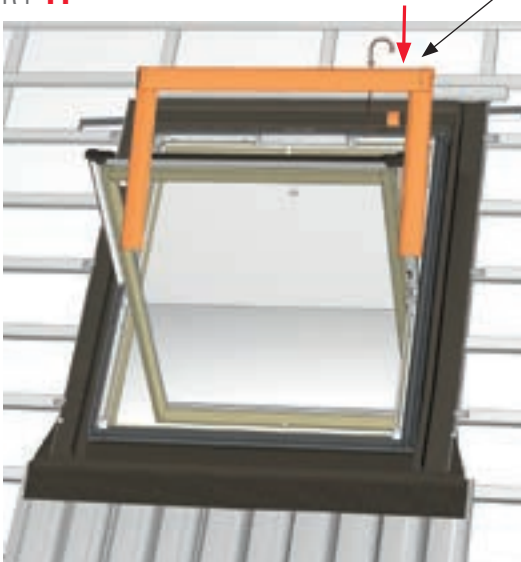

22 R4 K

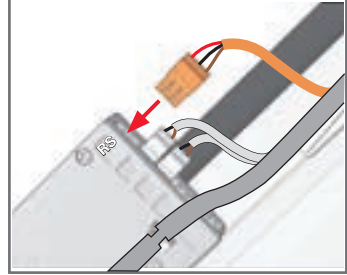
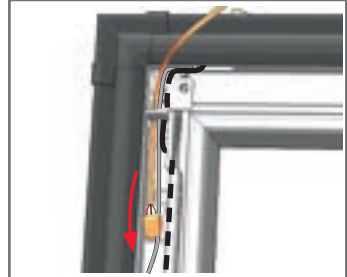
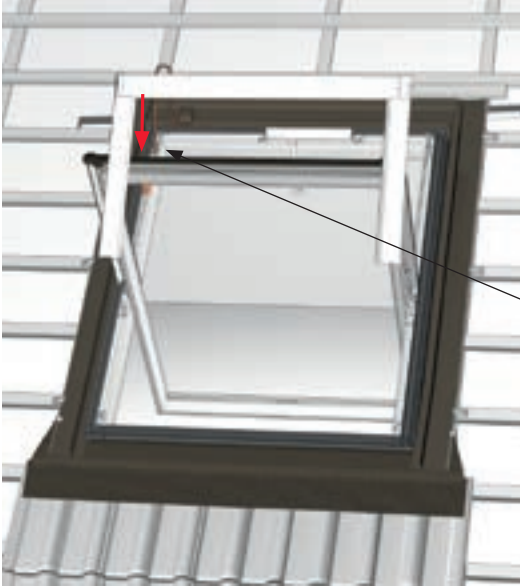

R4 H

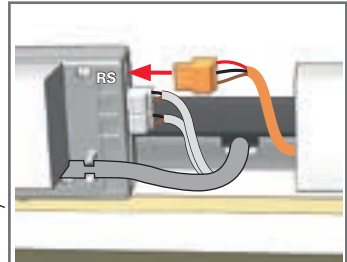
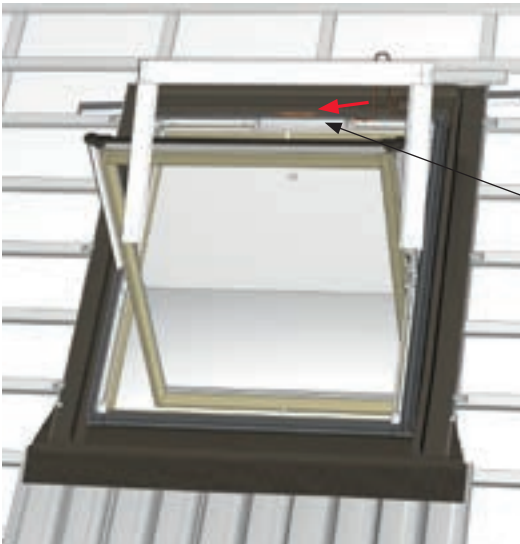

23

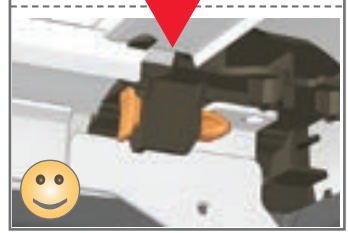
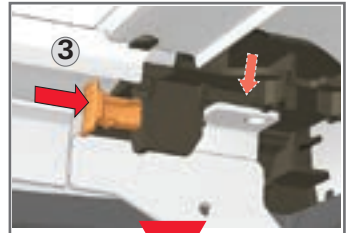
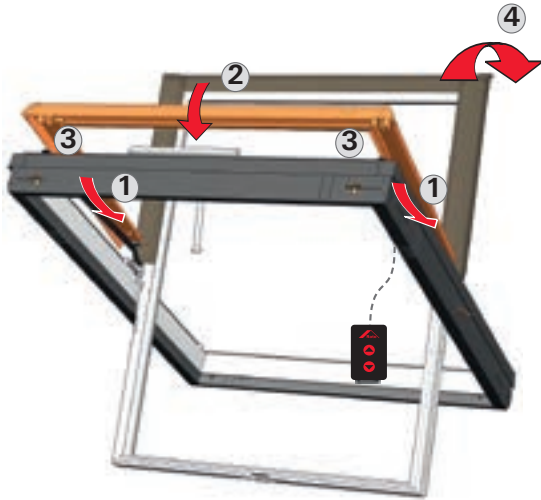

24

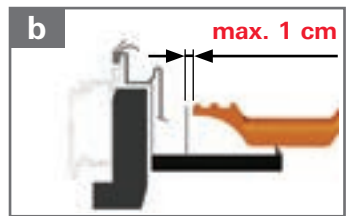
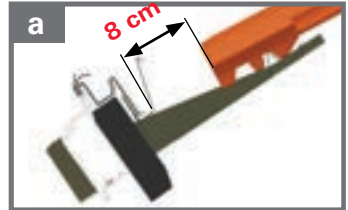
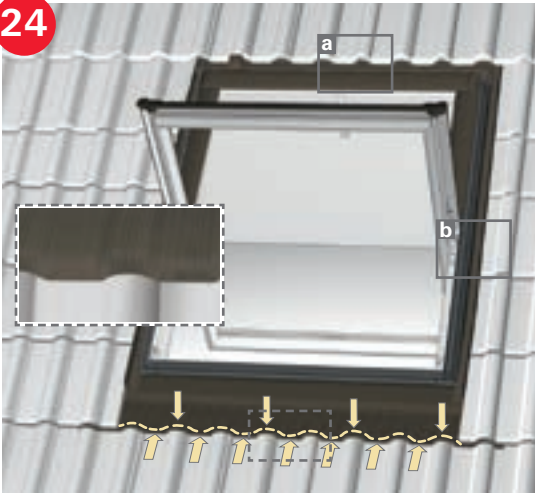



25

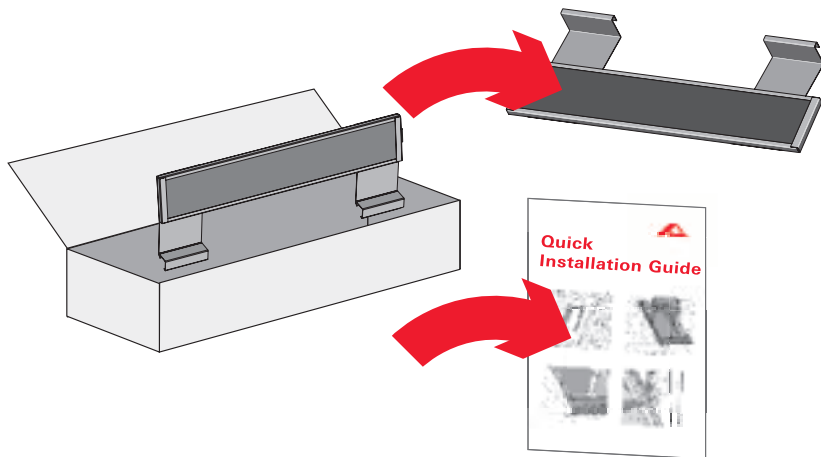

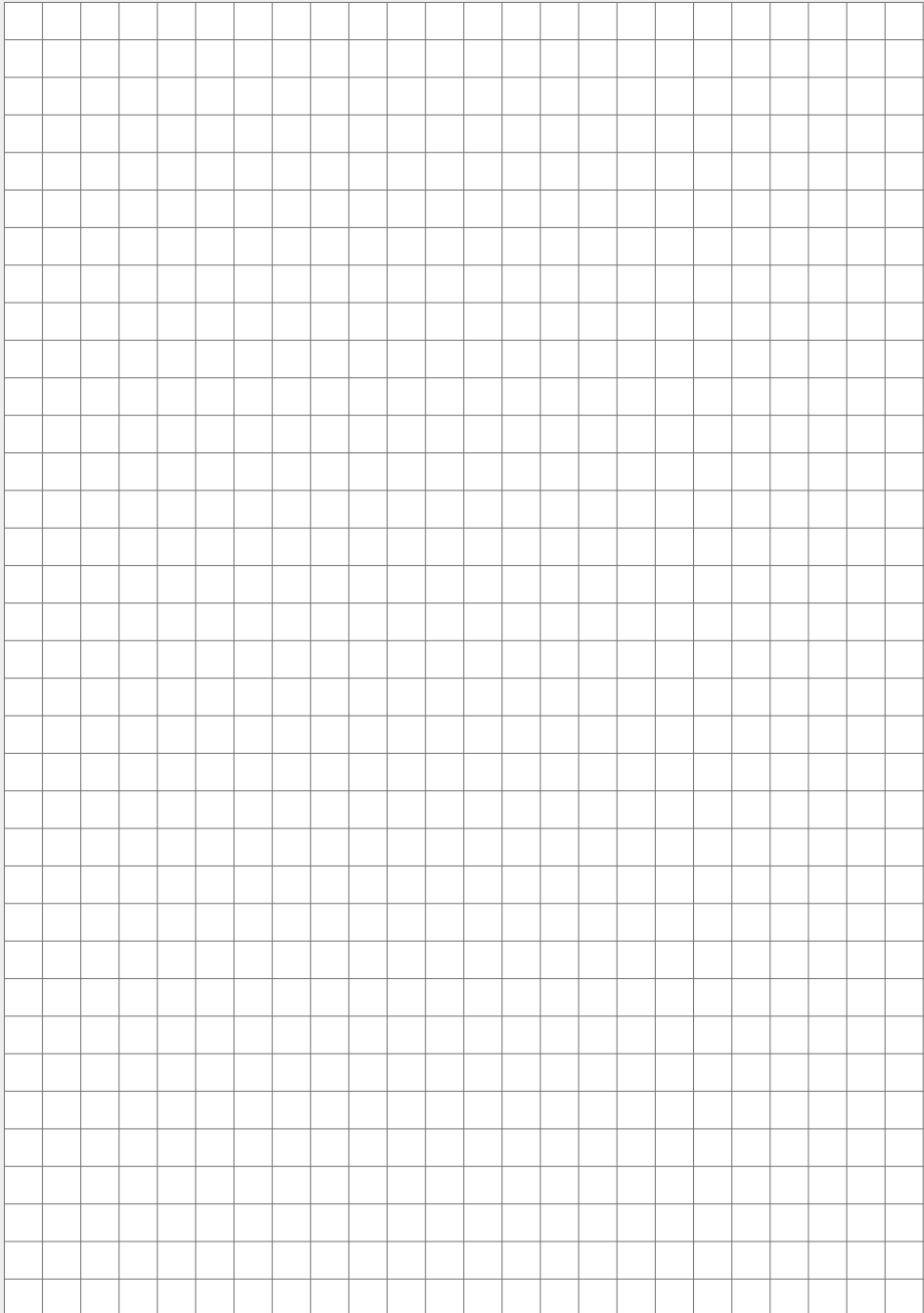

26

R4 **K**

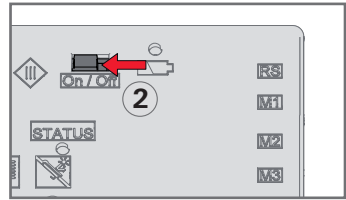
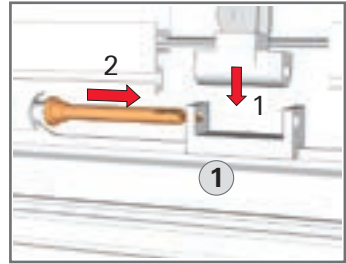
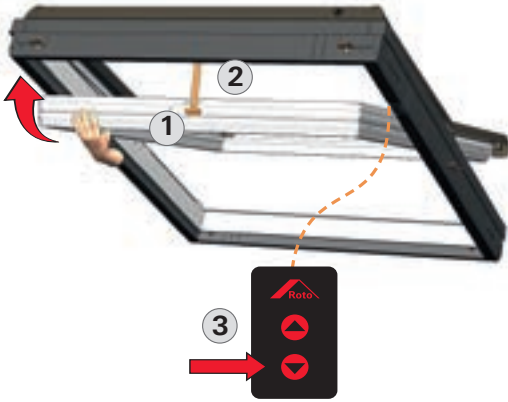

R4 **H**

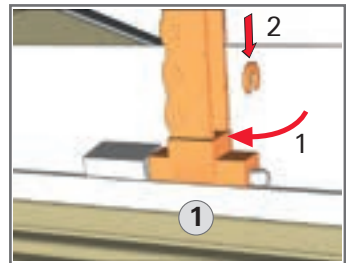
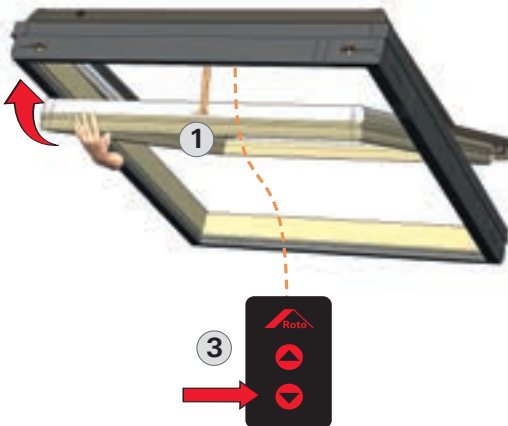

27

R4 **K**

 G 8x

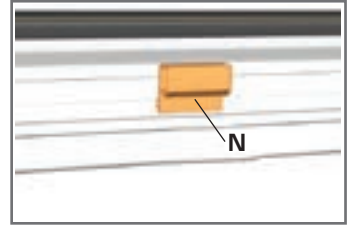

28

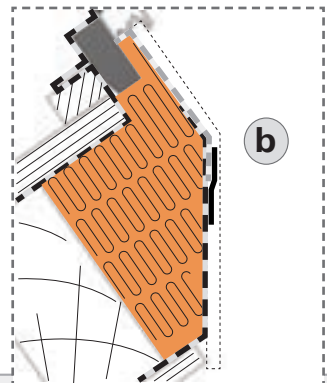
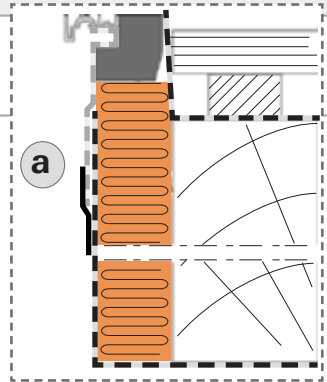
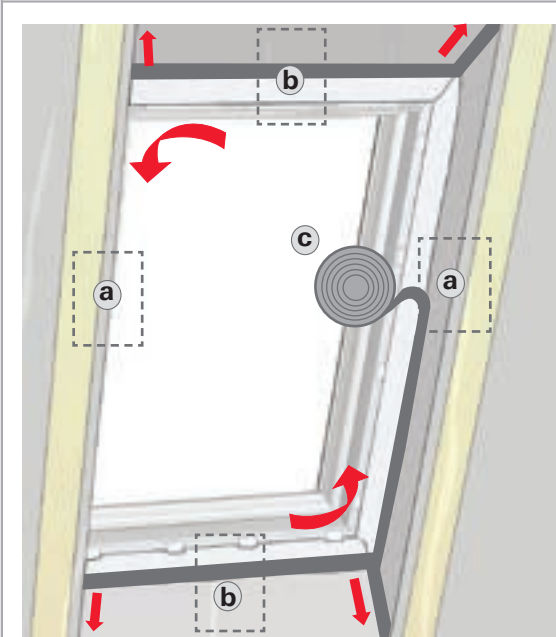

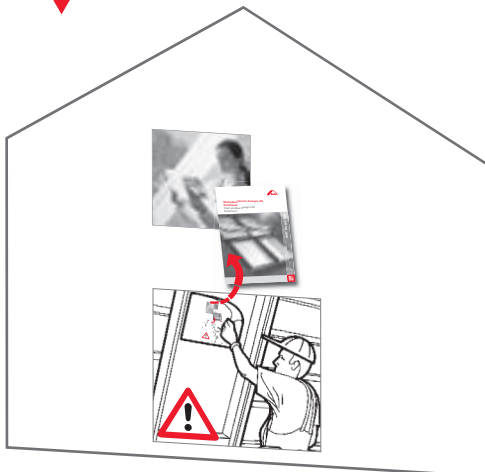
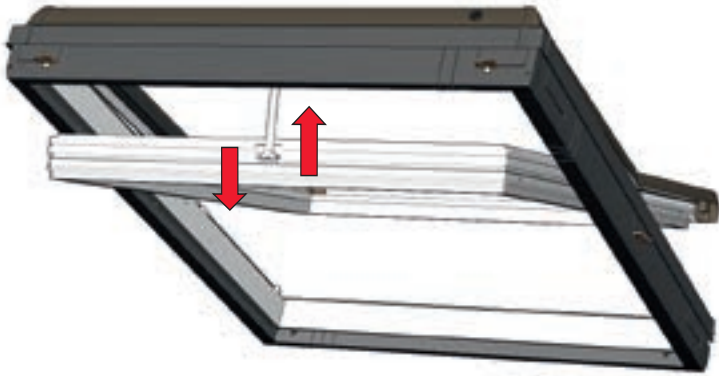

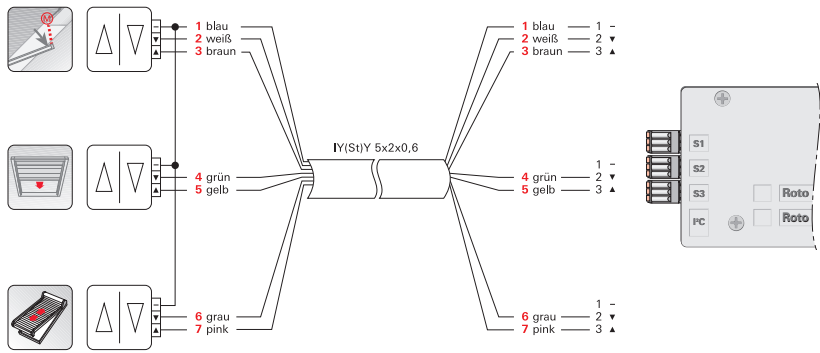

	1	2	3	4	5	6	7
	blau	weiß	braun	grün	gelb	grau	pink
	bleu	blanc	brun	vert	jaune	gris	rose
	blue	white	brown	green	yellow	grey	pink
	blauw	wit	bruin	groen	geel	grijs	roze
	azul	blanco	marrón	verde	amarillo	gris	rosa
	azul	branco	castanho	verde	amarelo	cinzento	cor-de-rosa
	niebieski	biały	brązowy	zielony	żółty	szary	różowy
	голубой	білий	коричневий	зелений	жёлтий	серый	розовий
	sinine	valge	pruun	roheline	kollane	hall	roosa
	zils	balts	brūns	zaļš	dzeltens	pelēks	sārts
	Žydra	balta	ruda	žalia	geltona	pilka	rožinė
	modrý	bílý	hnědý	zelený	žlutý	šedý	růžový
	modrý	biely	hnedý	zelený	žltý	šedý	ružový
	kék	fehér	barna	zöld	sárga	szürke	rózsaszín
	modra	bela	rjava	zelena	rumena	siva	roza
	Blu	Bianco	Marrone	Verde	Giallo	Grigio	Rosa
	plava	bijela	smeđa	zelena	žuta	siva	ružičasta
	albastru	alb	maro	verde	galben	gri	roz
	Μπλε	Λευκό	Καφέ	Πράσινο	Κίτρινο	Γκρι	Ρόζ

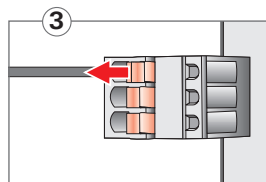
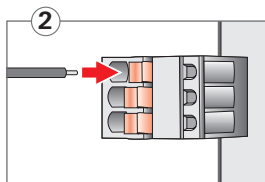
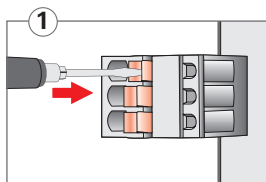

	Stift reindrücken und halten	Kabel in Buchse stecken	Stift loslassen
	Enfoncer la goupille et la maintenir	Enfoncer le câble dans la douille	Relâcher la goupille
	Push in the pin and keep it pushed in	Insert the cable into the socket	Release the pin
	Pen erin drukken en vasthouden	Kabel in bus steken	Pen loslaten
	Introducir el clavo presionándolo y mantenerlo en esa posición	Introducir el cable en el conector hembra	Soltar el clavo
	Pressionar o pino para dentro e segurar	Inserir o cabo na ficha	Soltar o pino
	Wcisnąć trzpień i przytrzymać	Wetknąć kabel do gniazda	Puścić trzpień
	Вдавить и удерживать штифт	Вставить кабель в гнездо	Отпустить штифт
	Vajutage tihvt sisse ja hoidke all	Pistke kaabel pesasse	Laske tihvt lahti
	Iespiediet tapu un pieturiet	Ielieciet kabeli iemavā	Atlaidiet tapu
	Pastumkíte ir laikykite strypą	Įstatykite laidą į įvorę	Atleiskite strypą
	Kolík vtlačte a držte jej	Kabel zastrčte do zdičky	Kolík uvolněte
	Kolík zatlačte dovnútra a podržte	Zastrčte kábel do zdičky	Kolík pustite
	Nyomja be, és tartsa a csapos dugaszoló	Dugja be a kábelt a kapcsolóhüvelybe	Engedje el a dugaszolót
	Zatič pritisnite in ga pridržite	Kabel vtaknite v pušo	Spustite zatič
	Premere dentro la spina e mantenerla ferma	Inserire il cavo nella boccola	Rilasciare la spina
	Utisnite i držite klin	Utaknite kabel u utičnicu	Pustite klin
	se apasă știftul și se ține	se conectează cablul	se eliberează știftul
	Πίεστε μέσα τον πείρο και κρατήστε τον	Βυσματώστε το καλώδιο στην υποδοχή	Αφήστε τον πείρο ελεύθερο



The roof window.



www.roto-contacts.com



www.roto-extra.com

Roto Frank DST Vertriebs-GmbH
Wilhelm-Frank-Straße 38-40
97980 Bad Mergentheim
Deutschland

