

EKZ/EKW/EKX ■

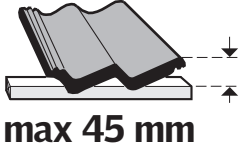

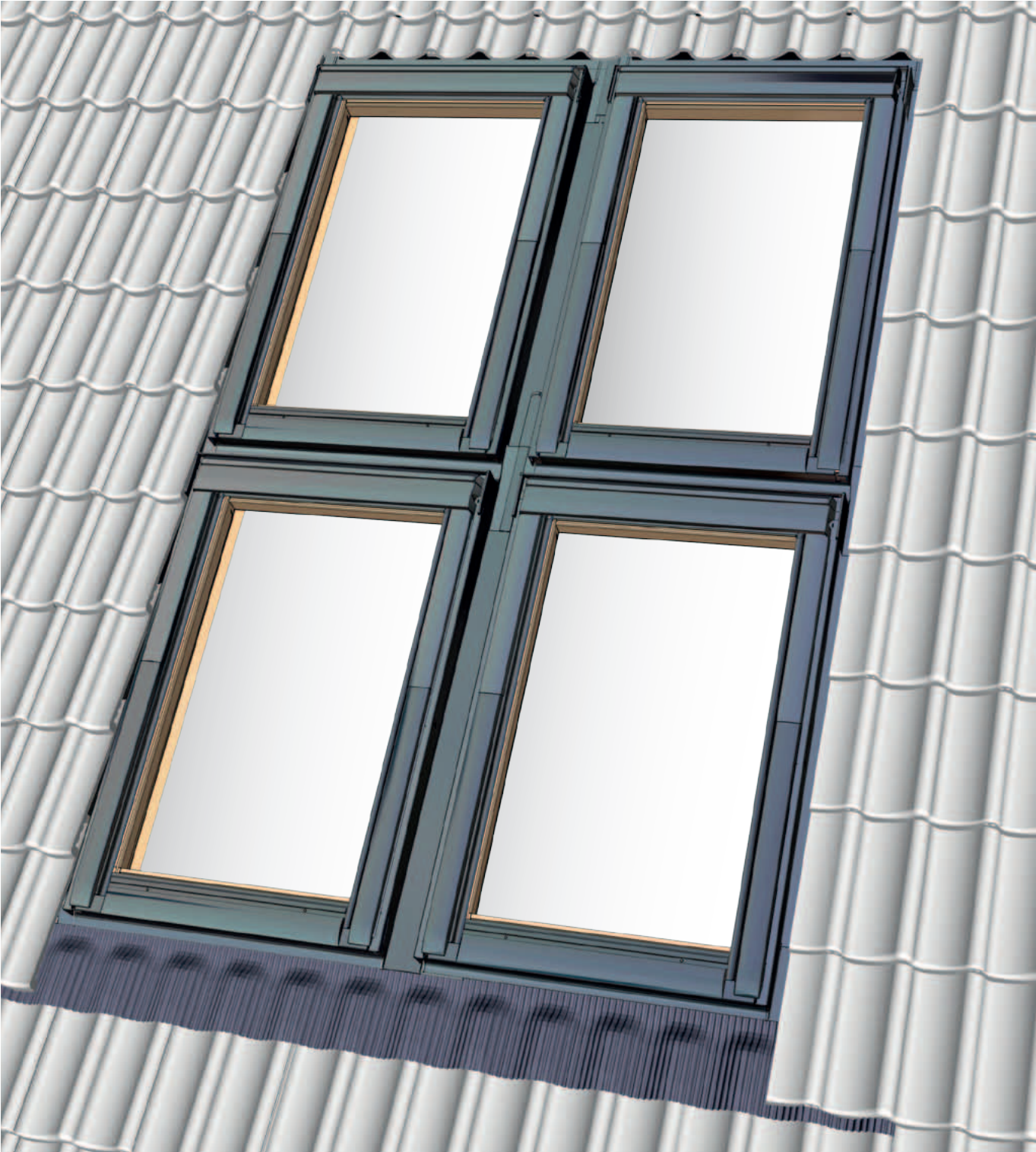

0001

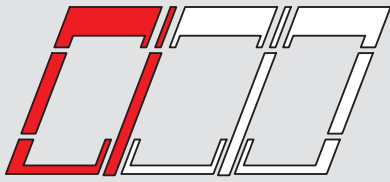
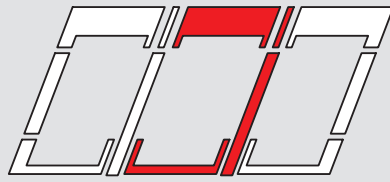

0002

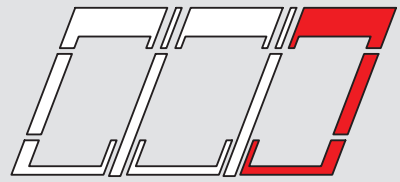

0003

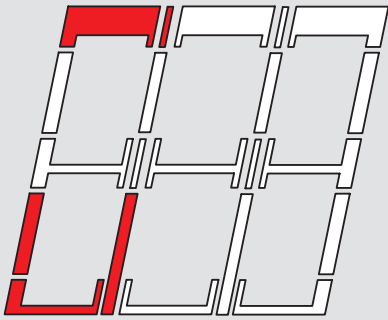

0001

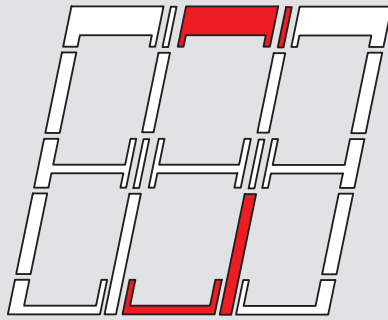

0002

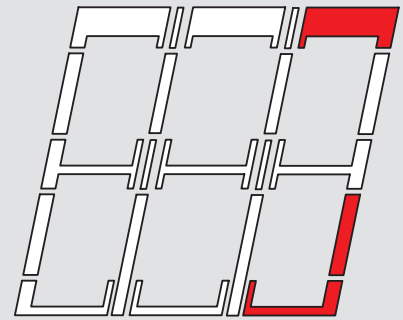

0003

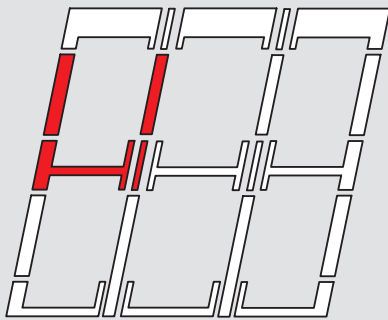

0004

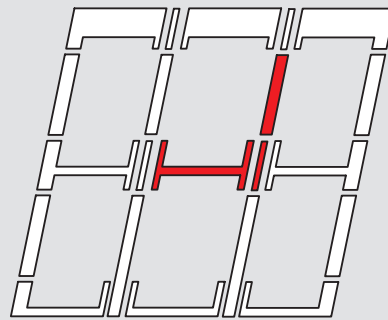

0005

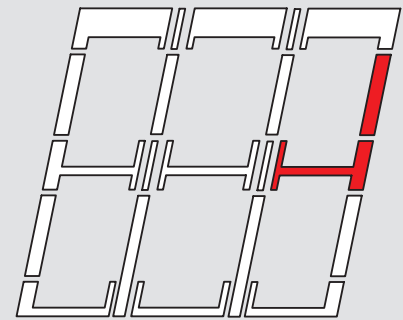

0006

1

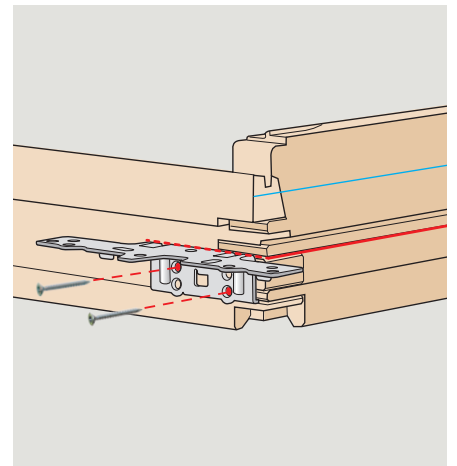
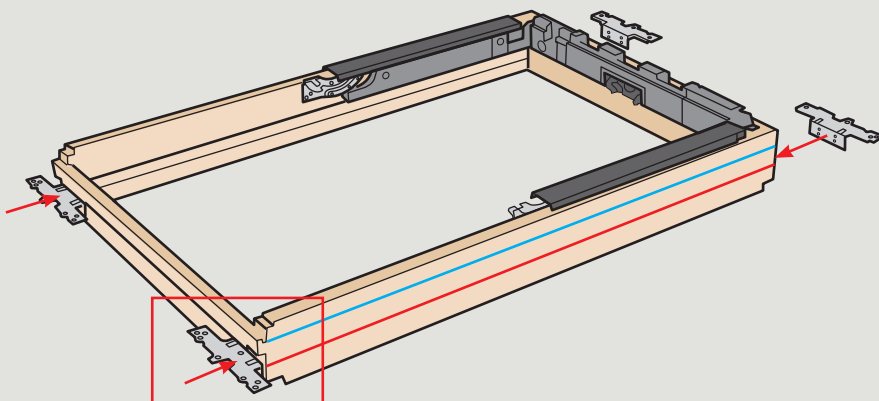

30 mm

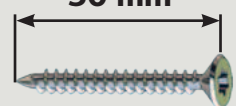

2

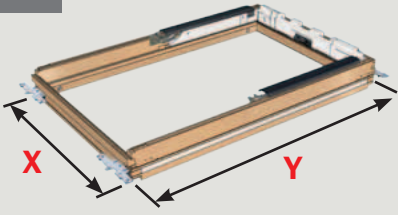

$a = xx \text{ mm}$
 $b = xx \text{ mm}$

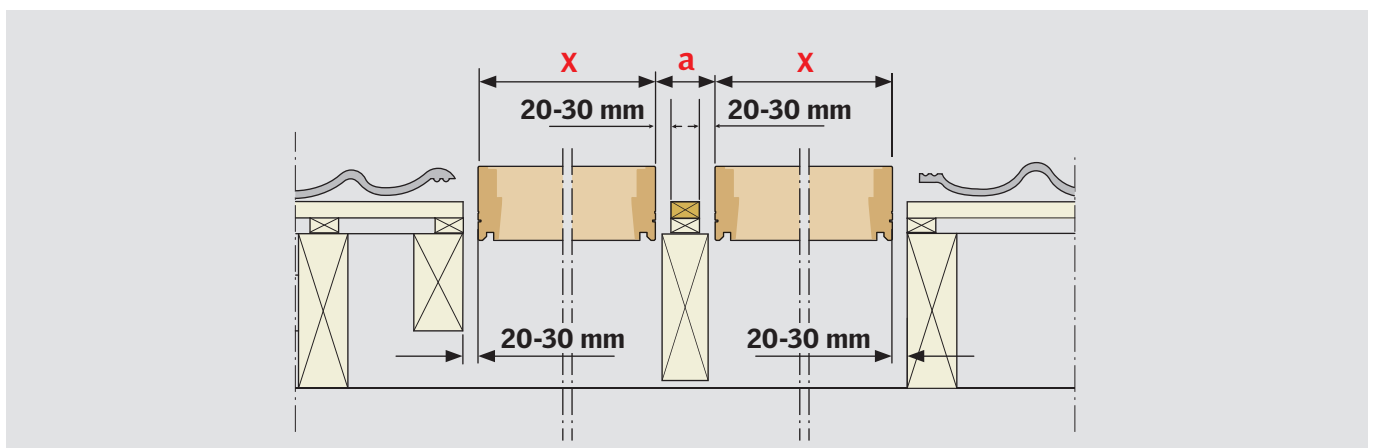
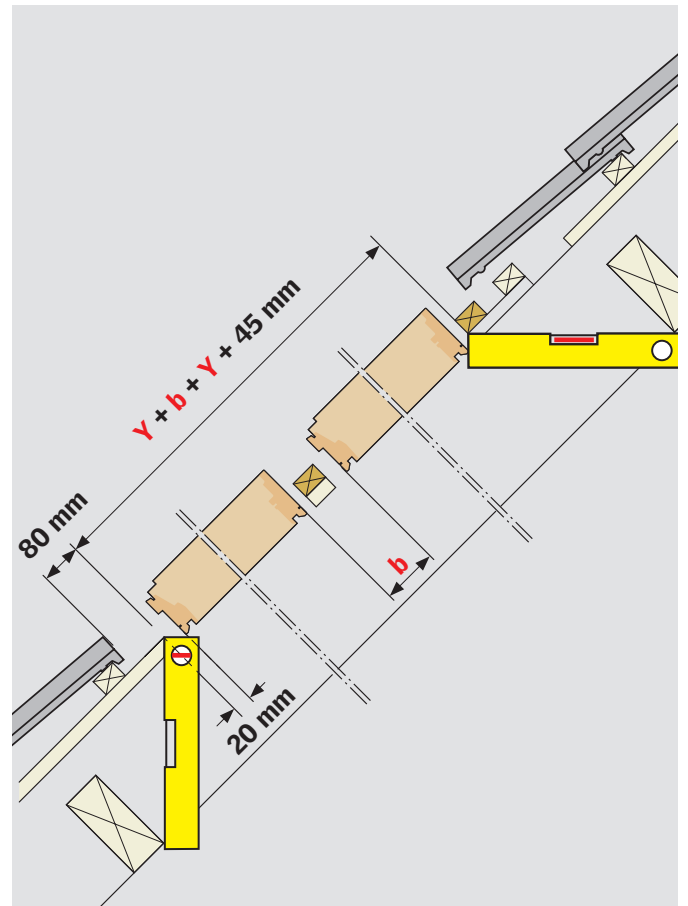
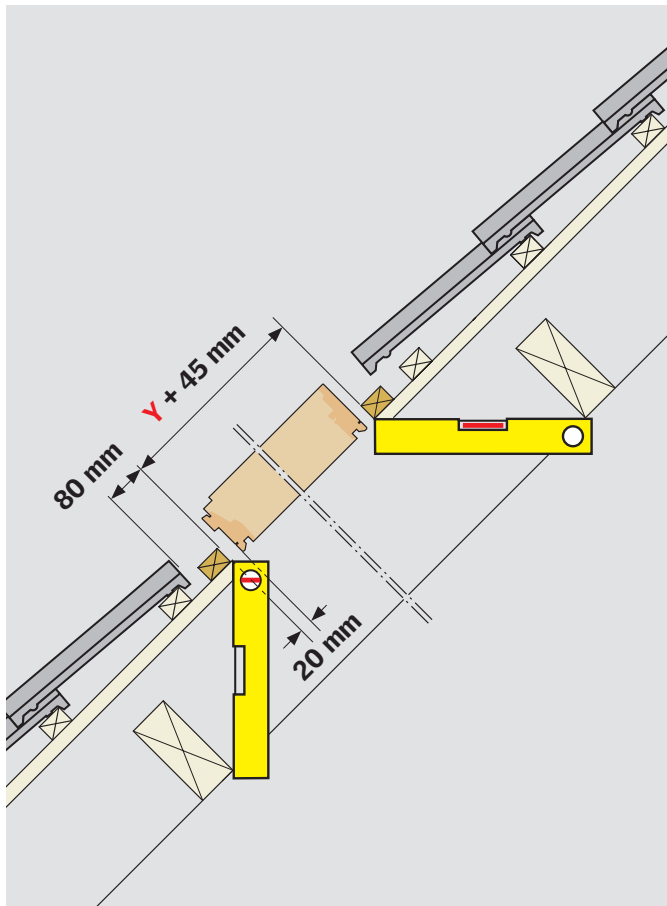
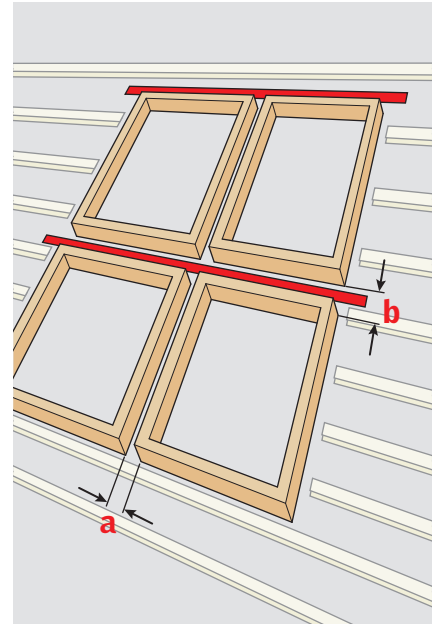
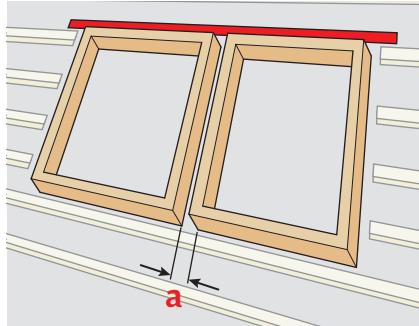
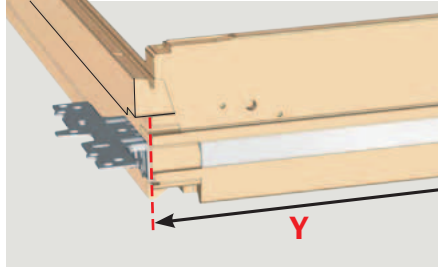

3

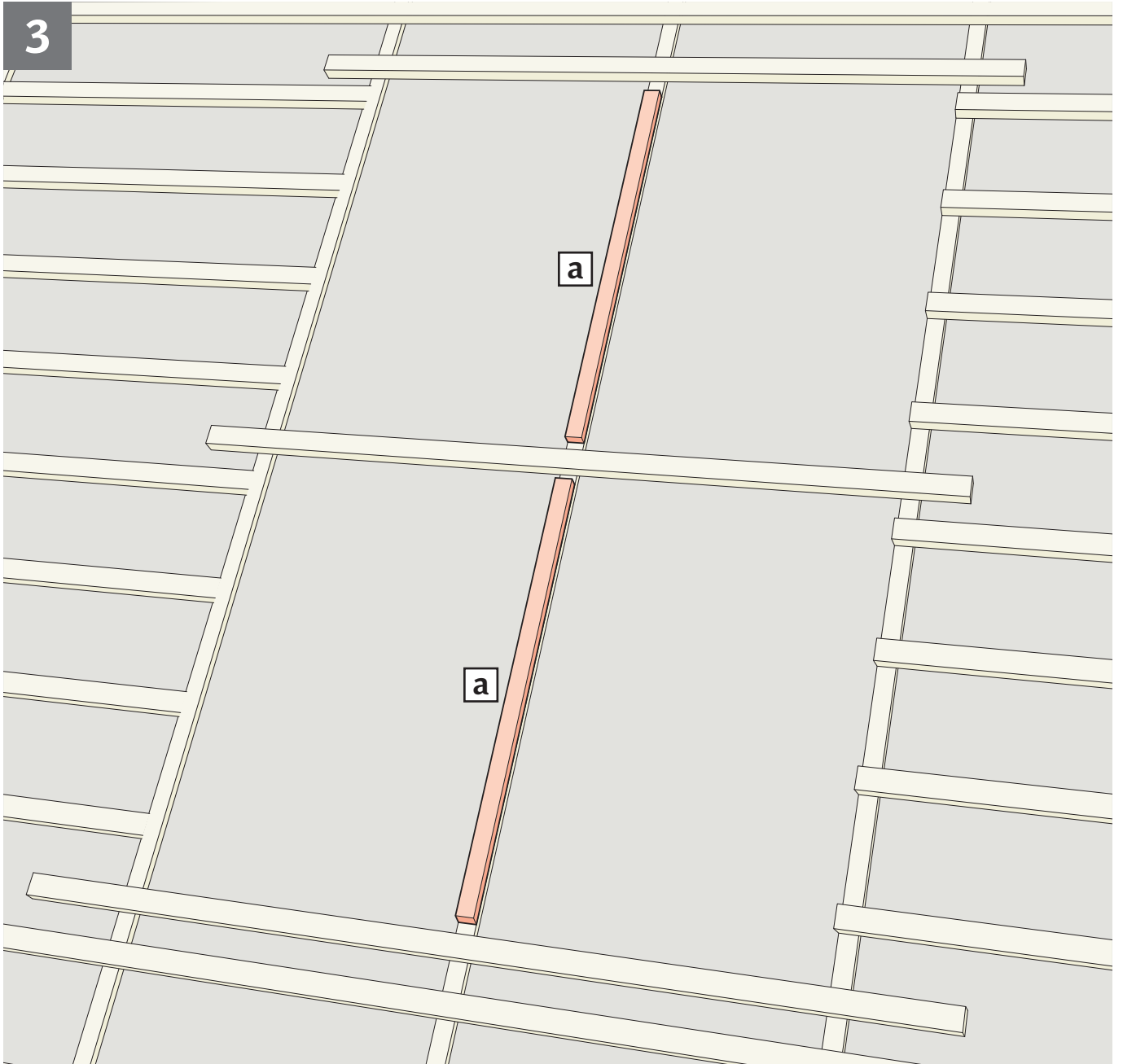

a

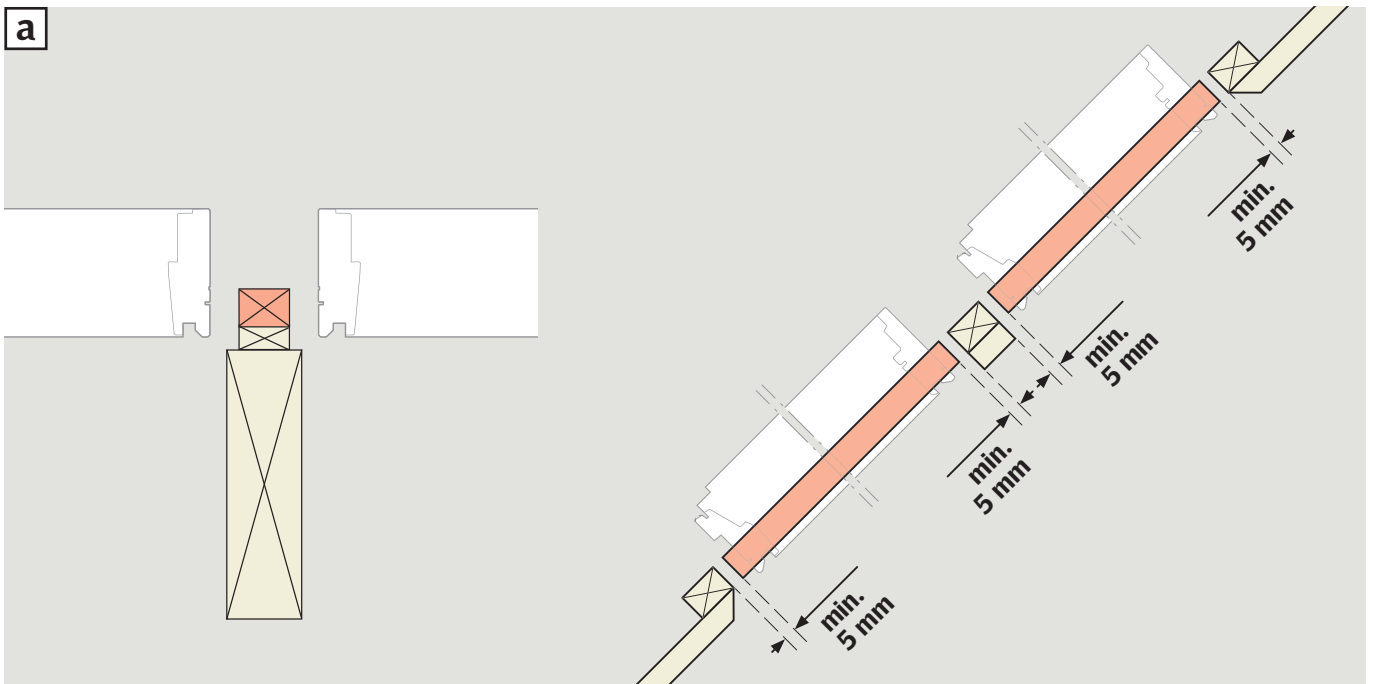

4

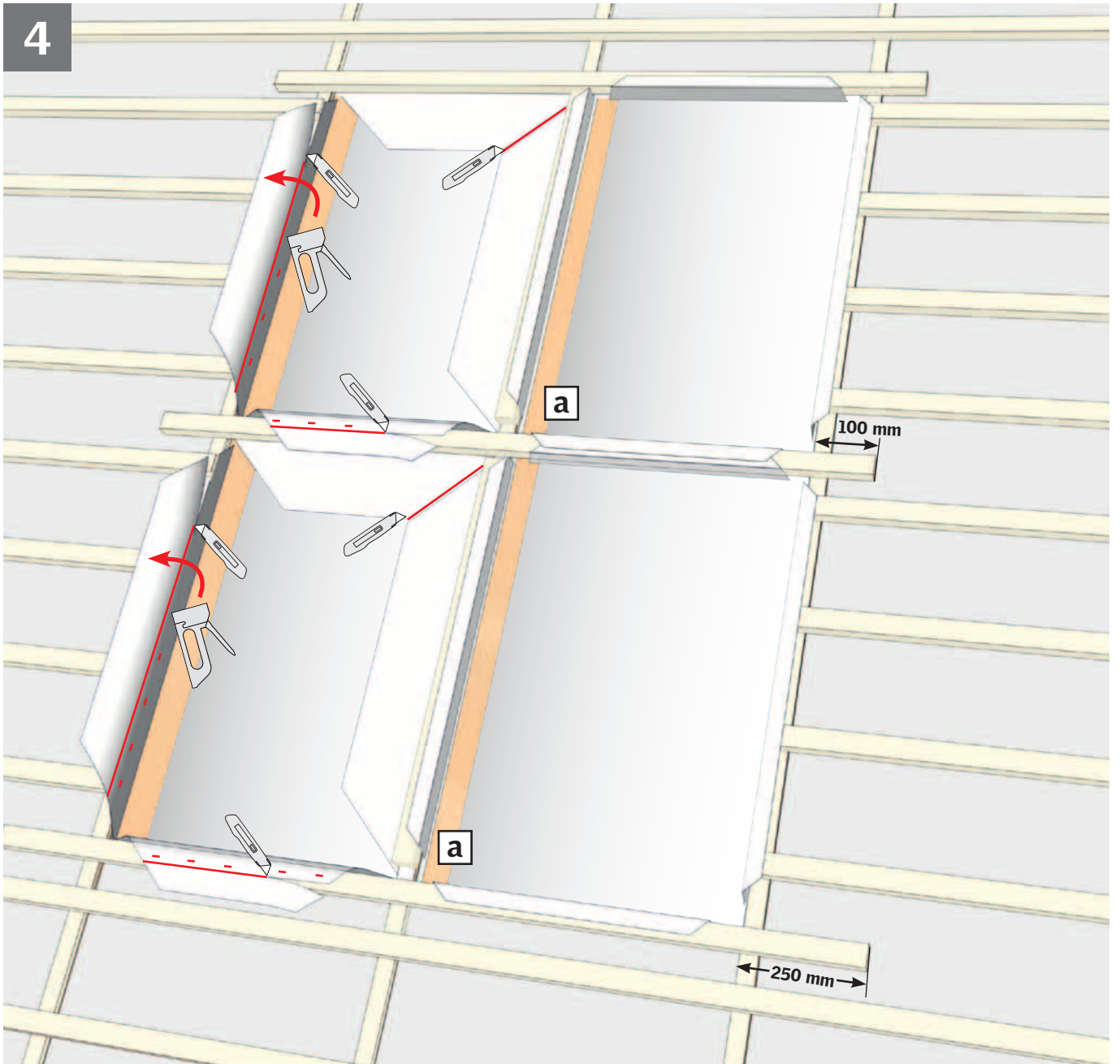

5

BDX

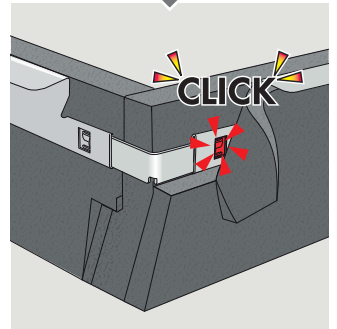
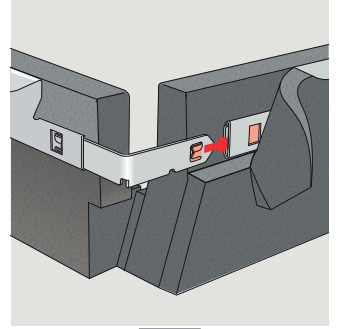
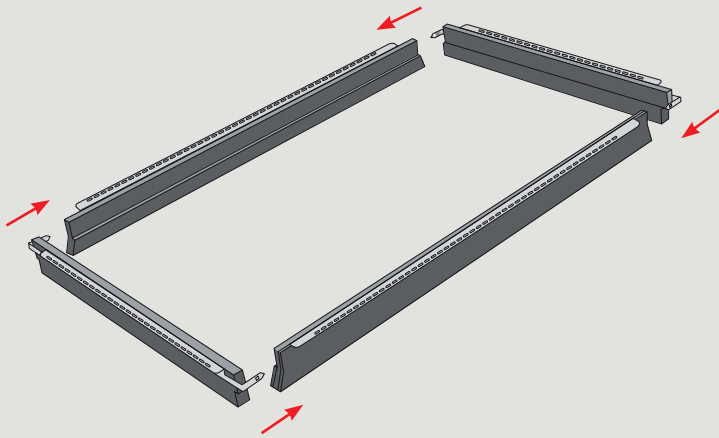

6

BDX

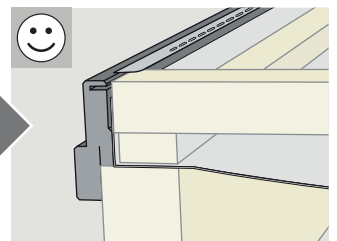
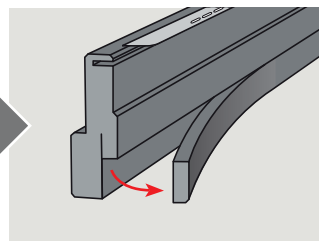
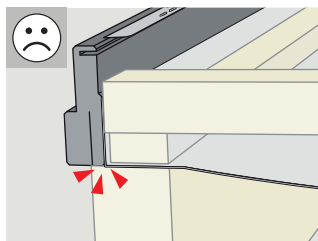
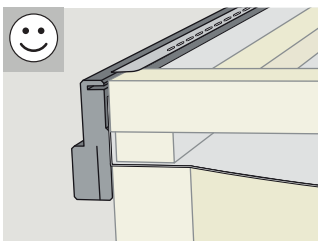
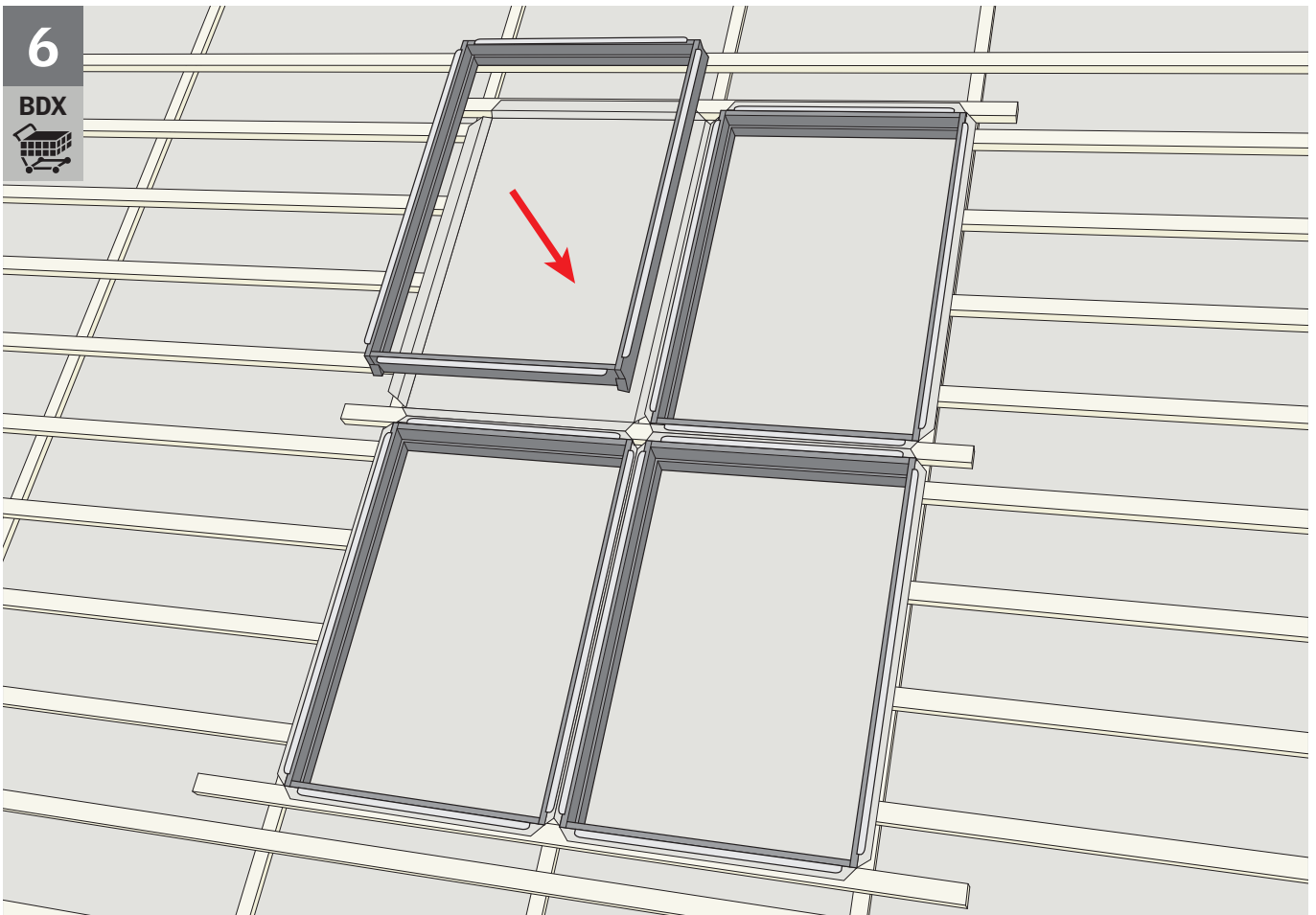

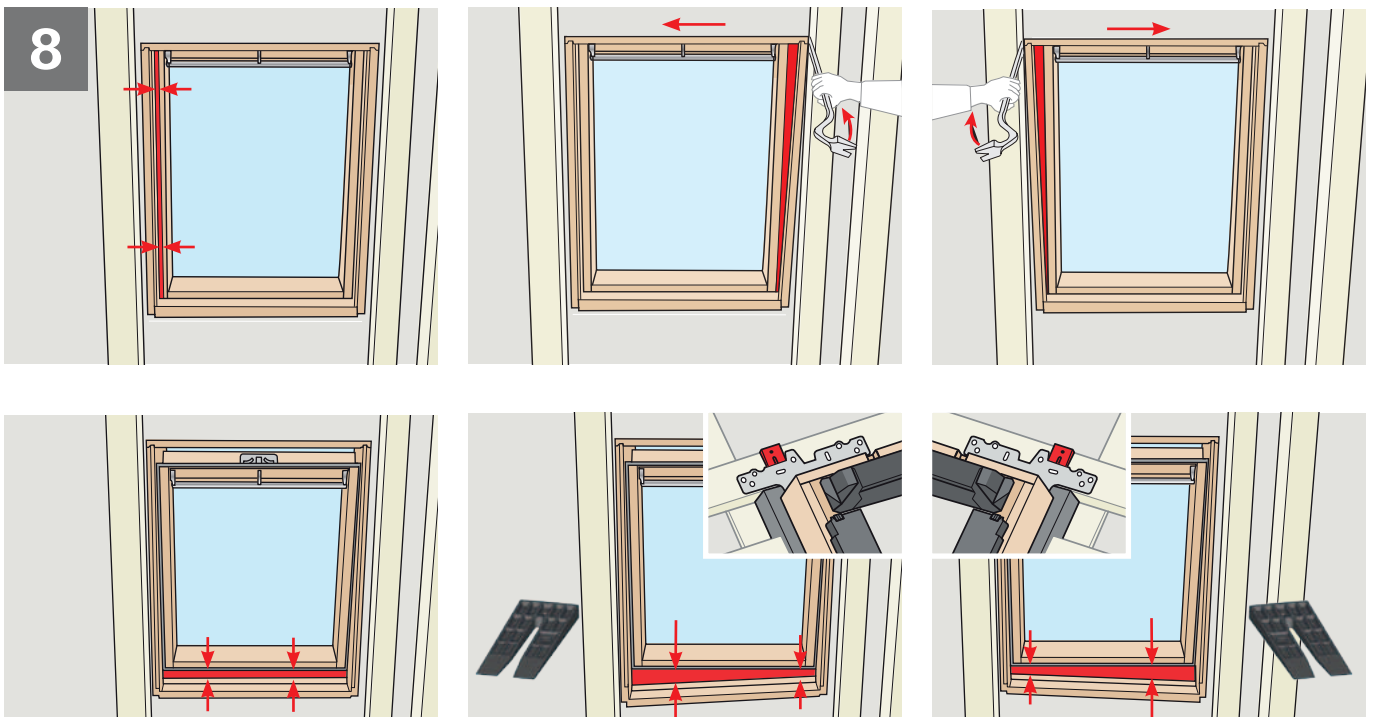
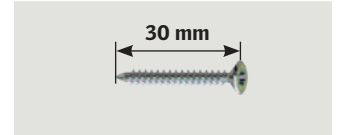
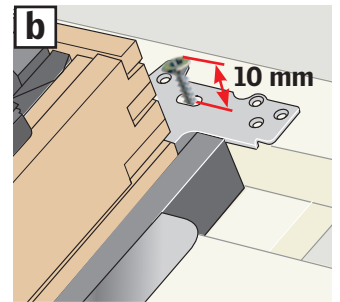
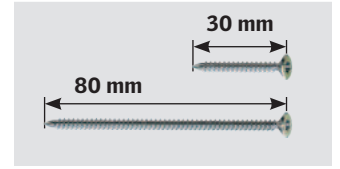
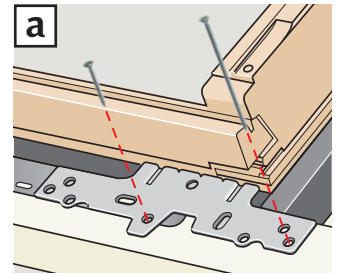
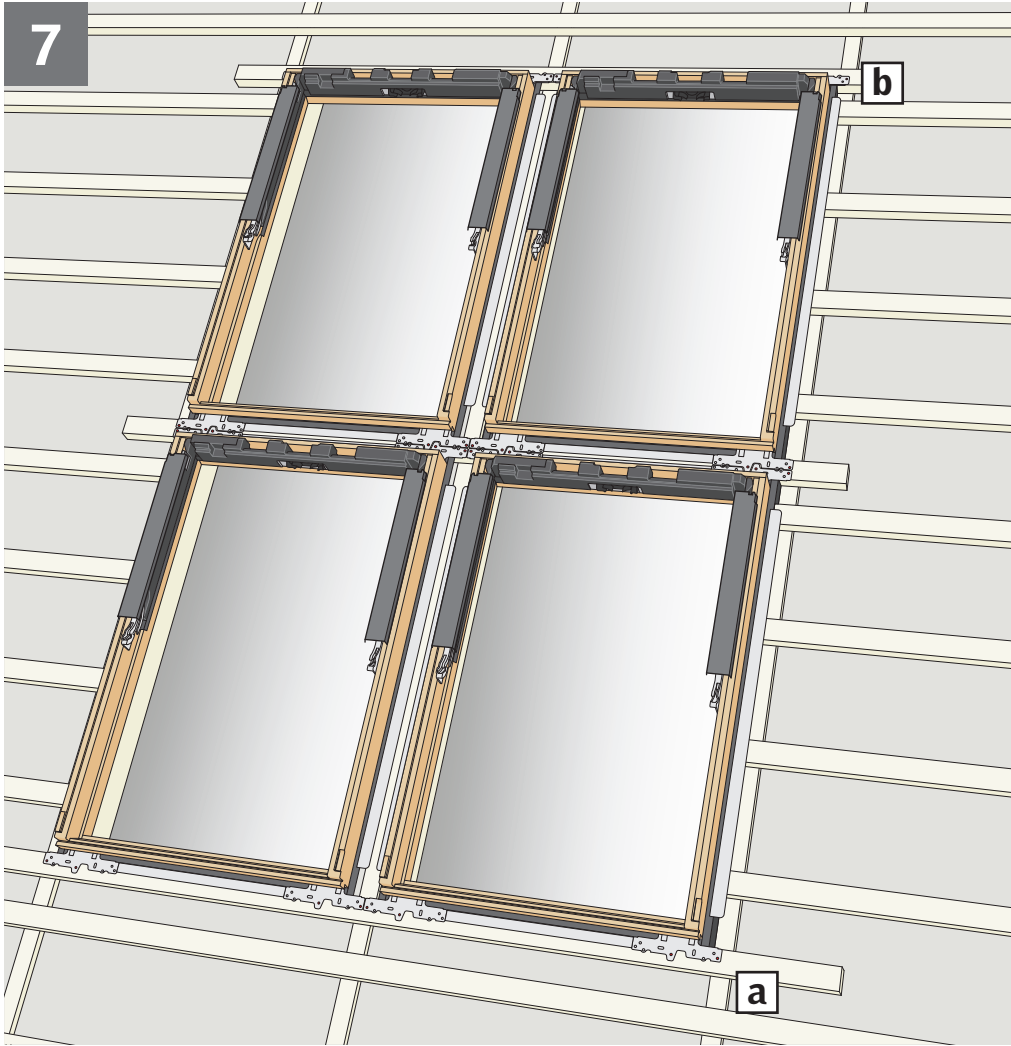

9

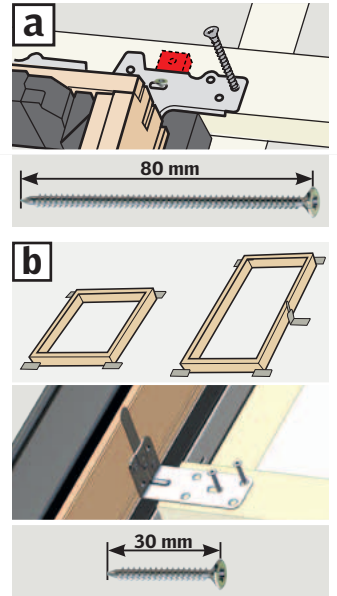
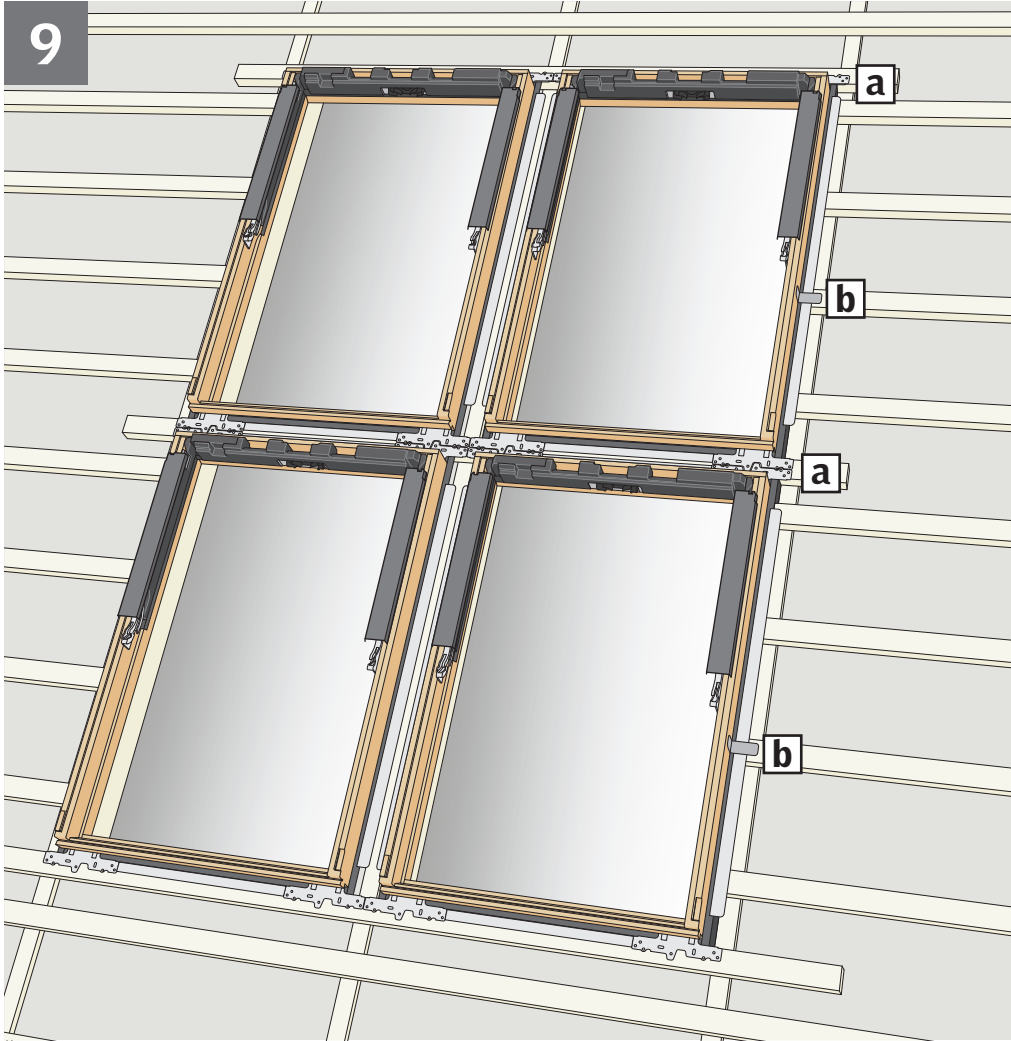

10

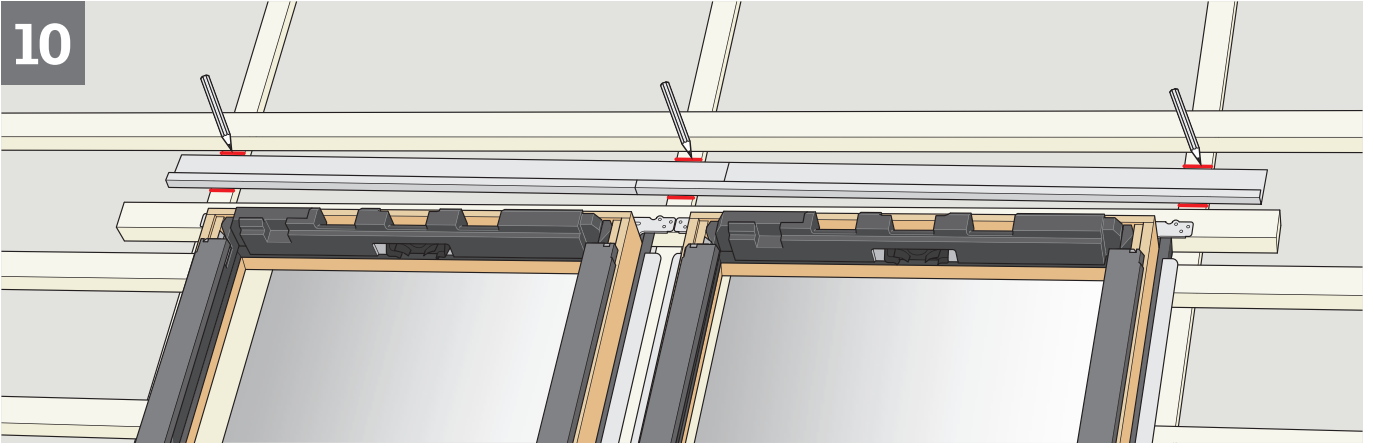

11

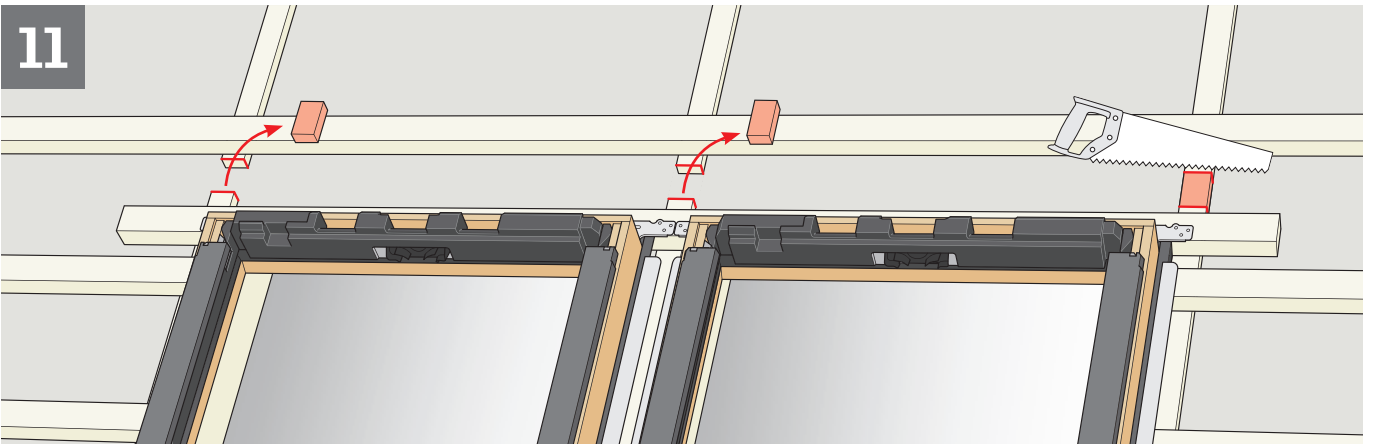

12

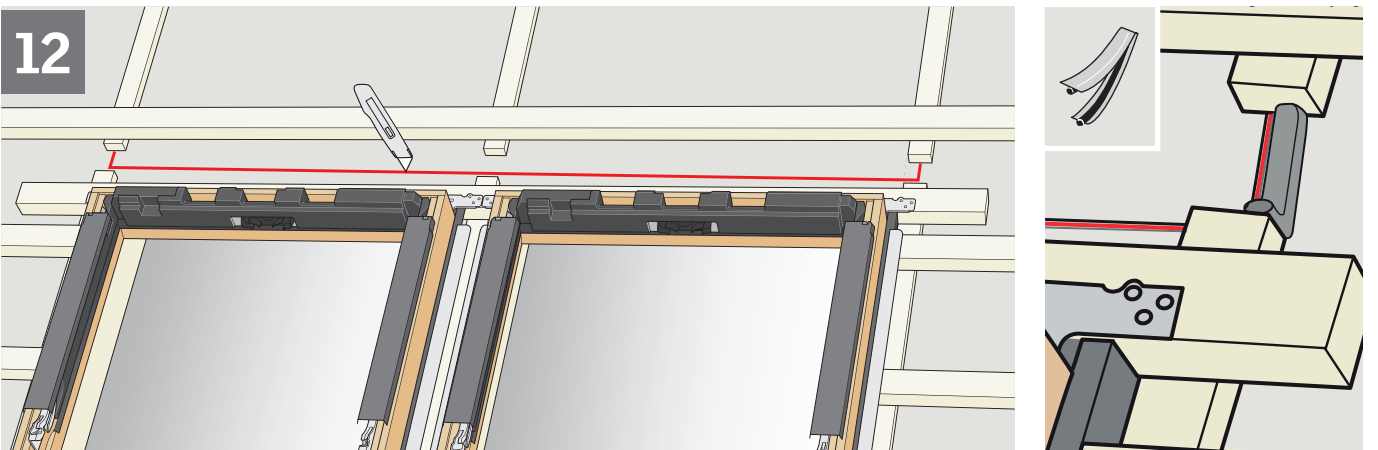

BFX

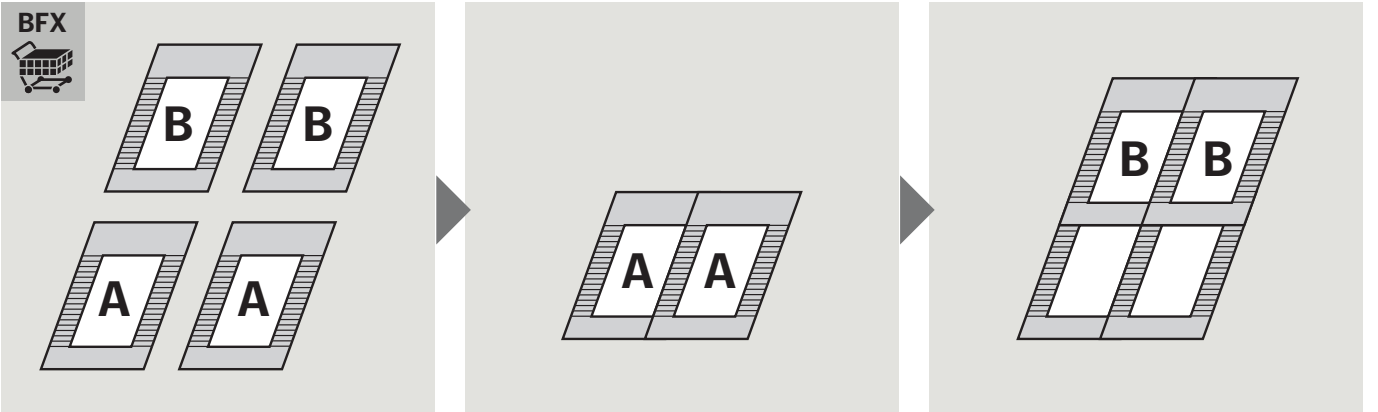

13

BFX

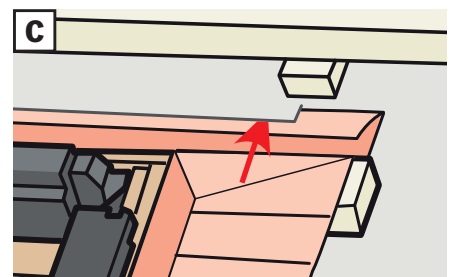
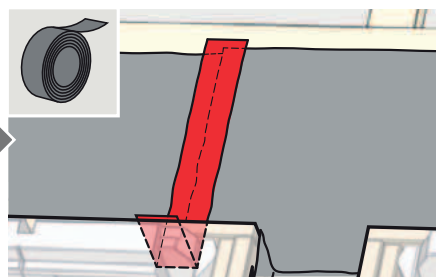
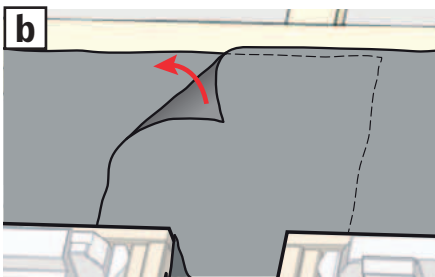
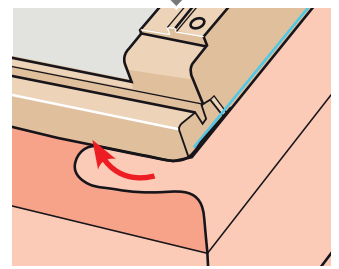
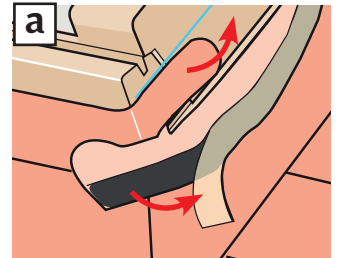
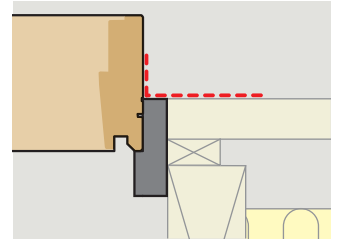
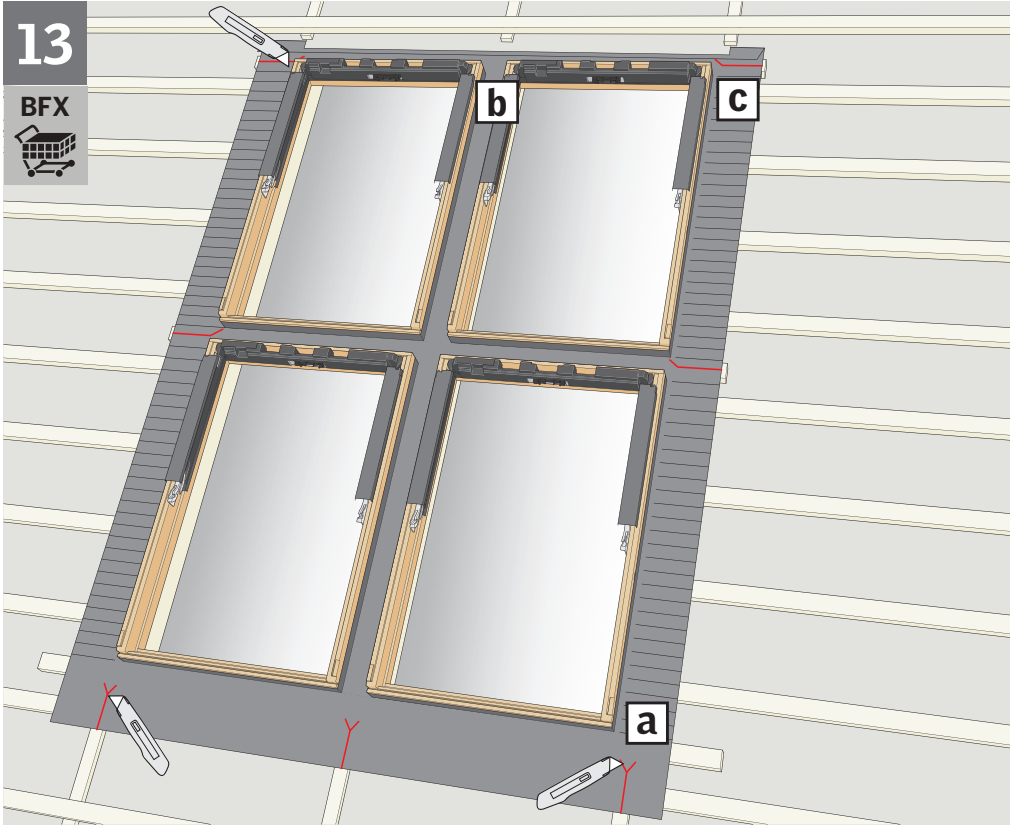

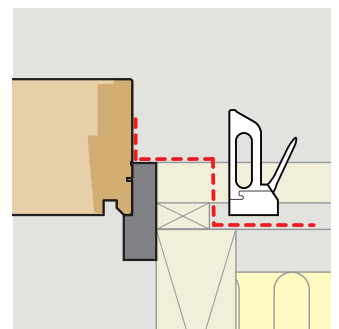
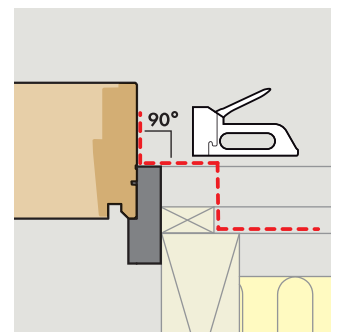
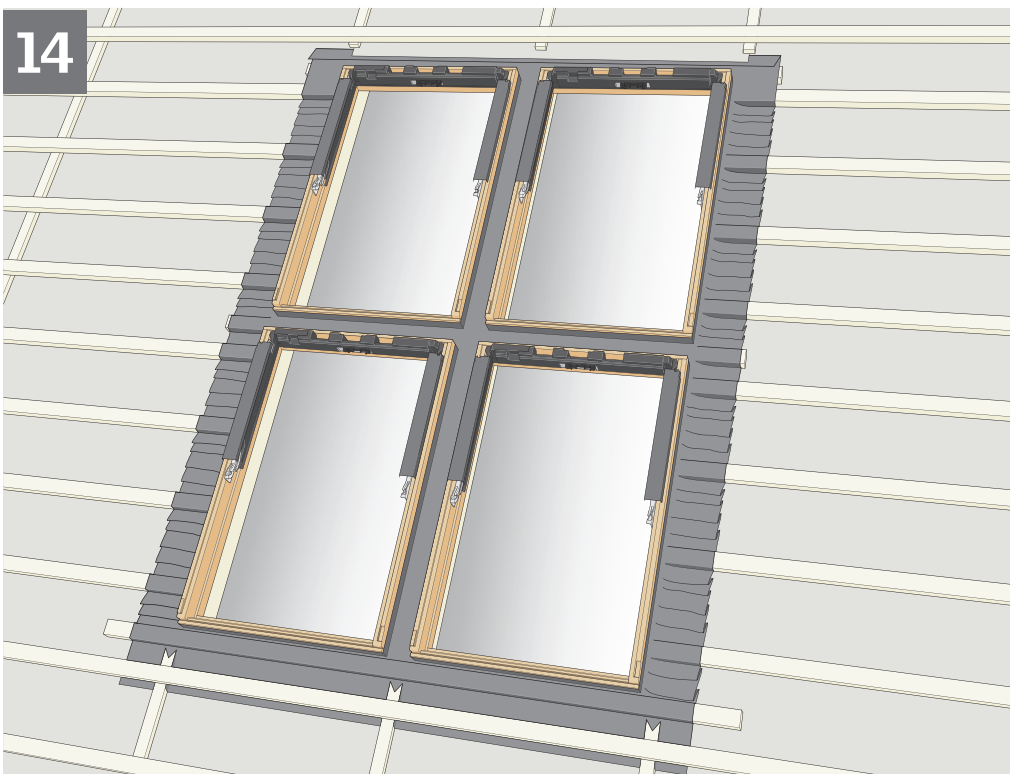

14

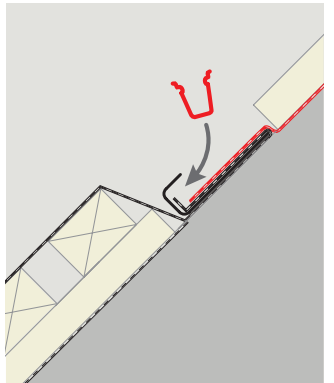
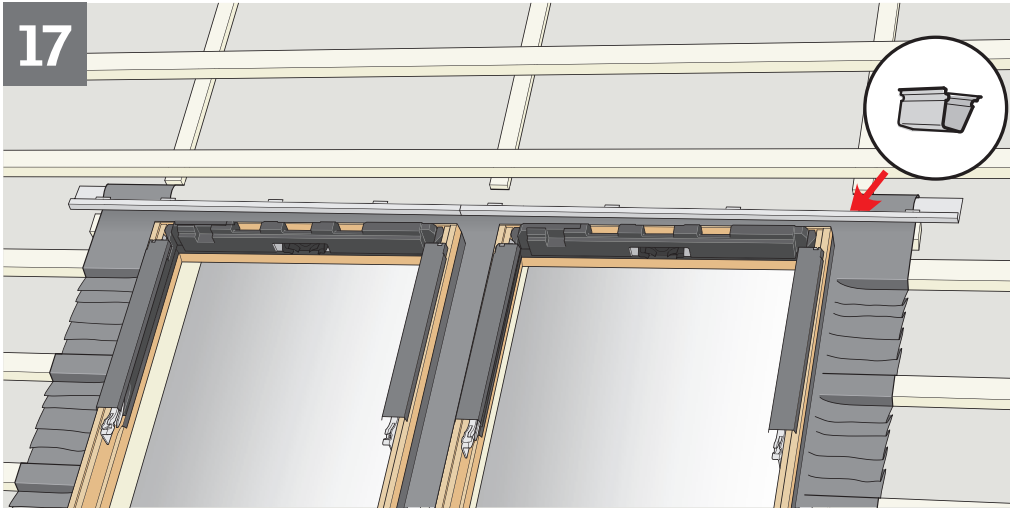
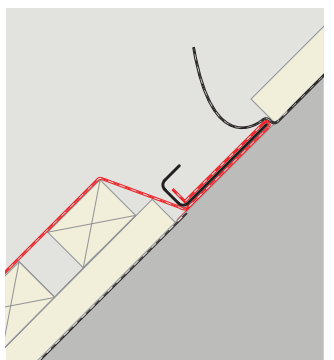
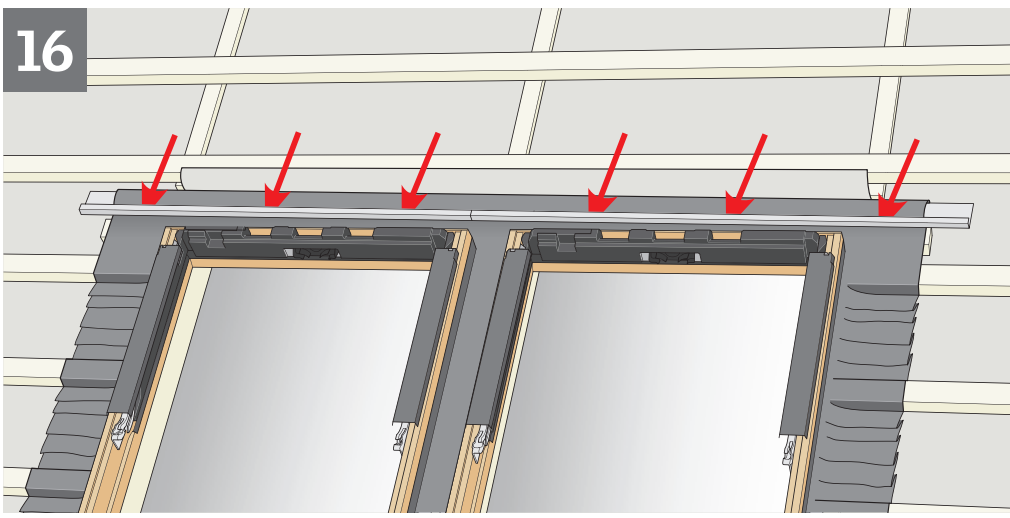
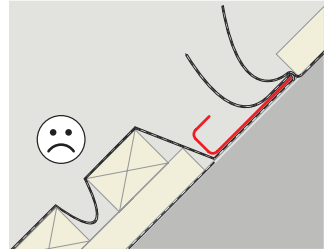
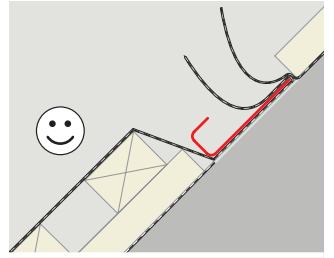
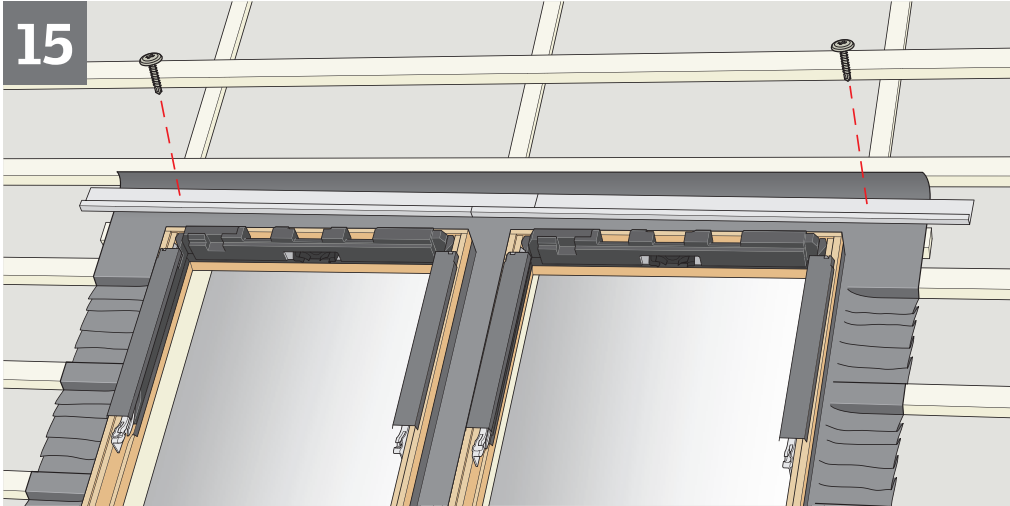

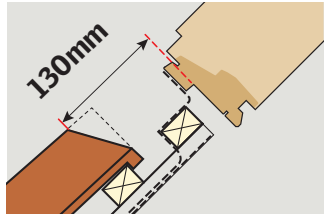
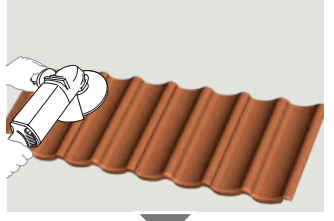
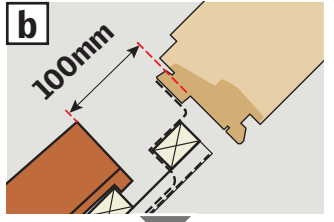
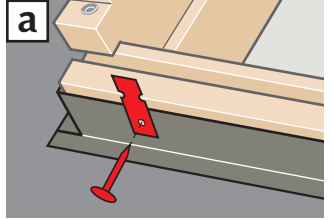
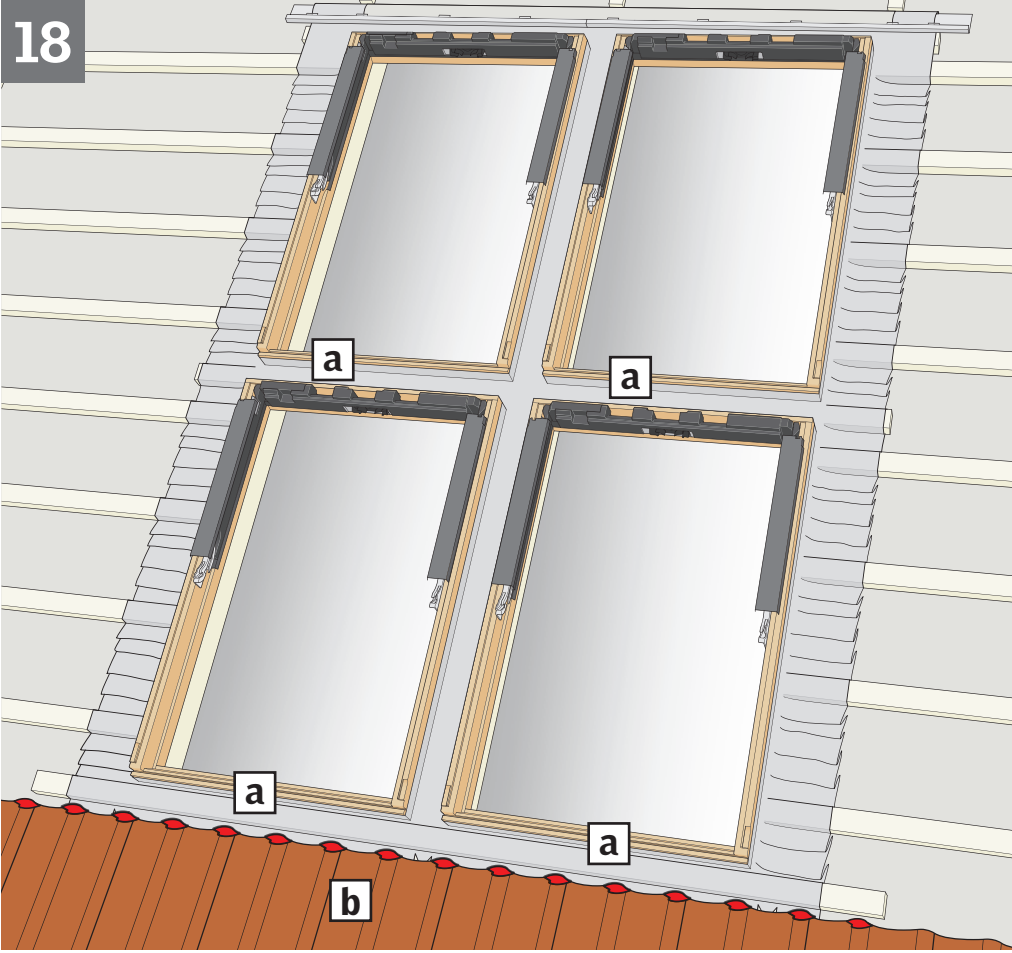

18



19

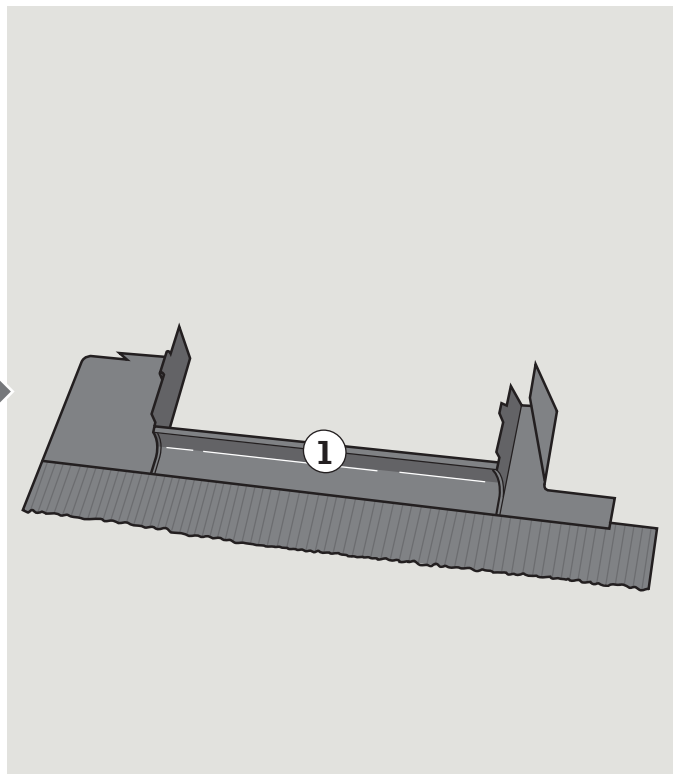
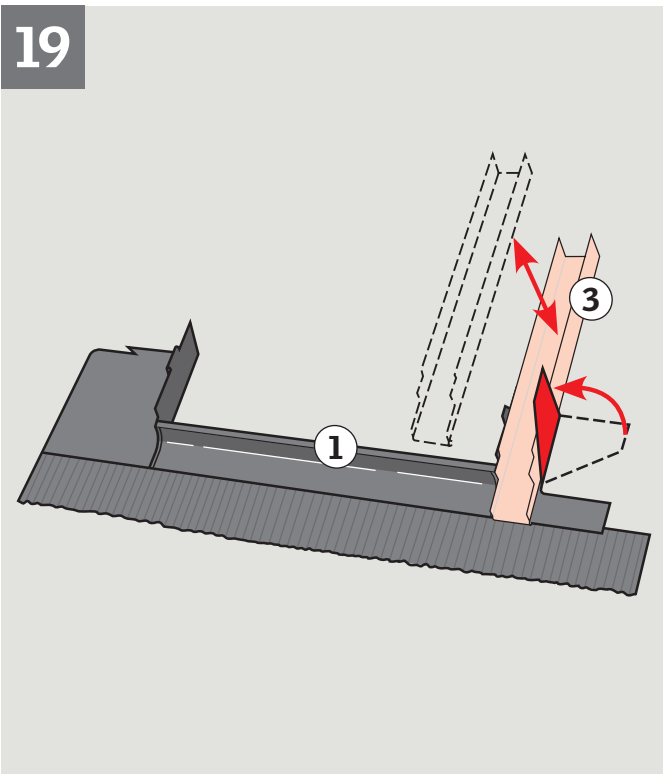

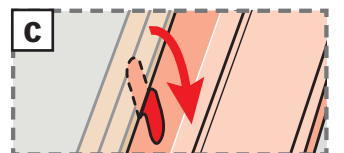
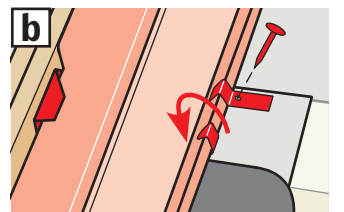
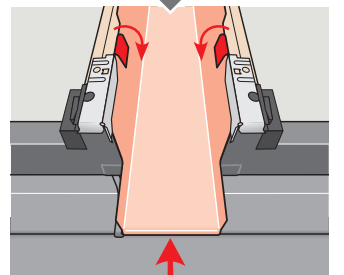
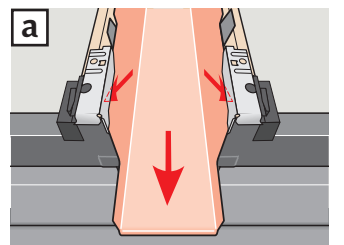
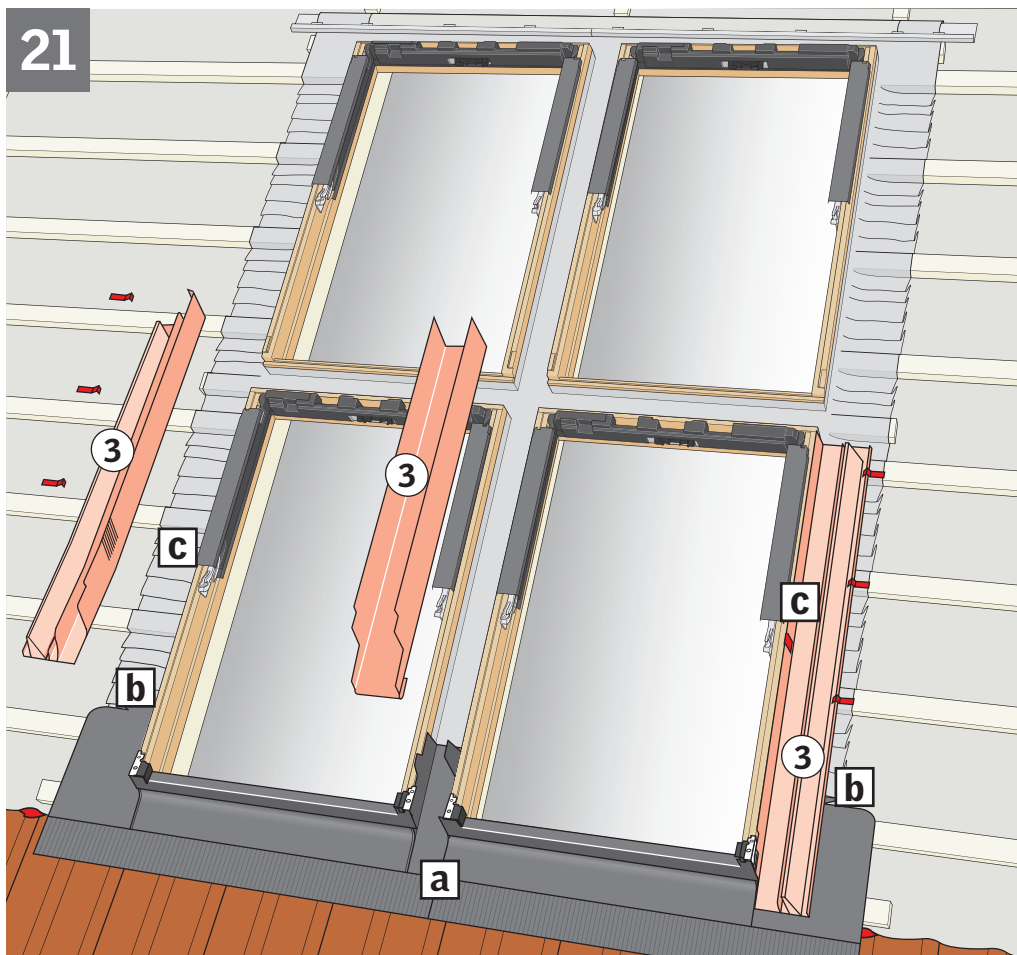
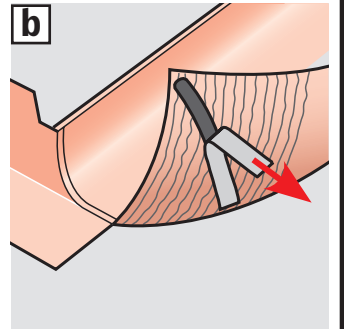
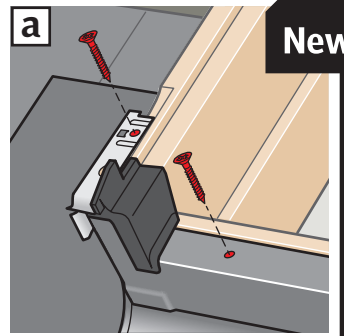
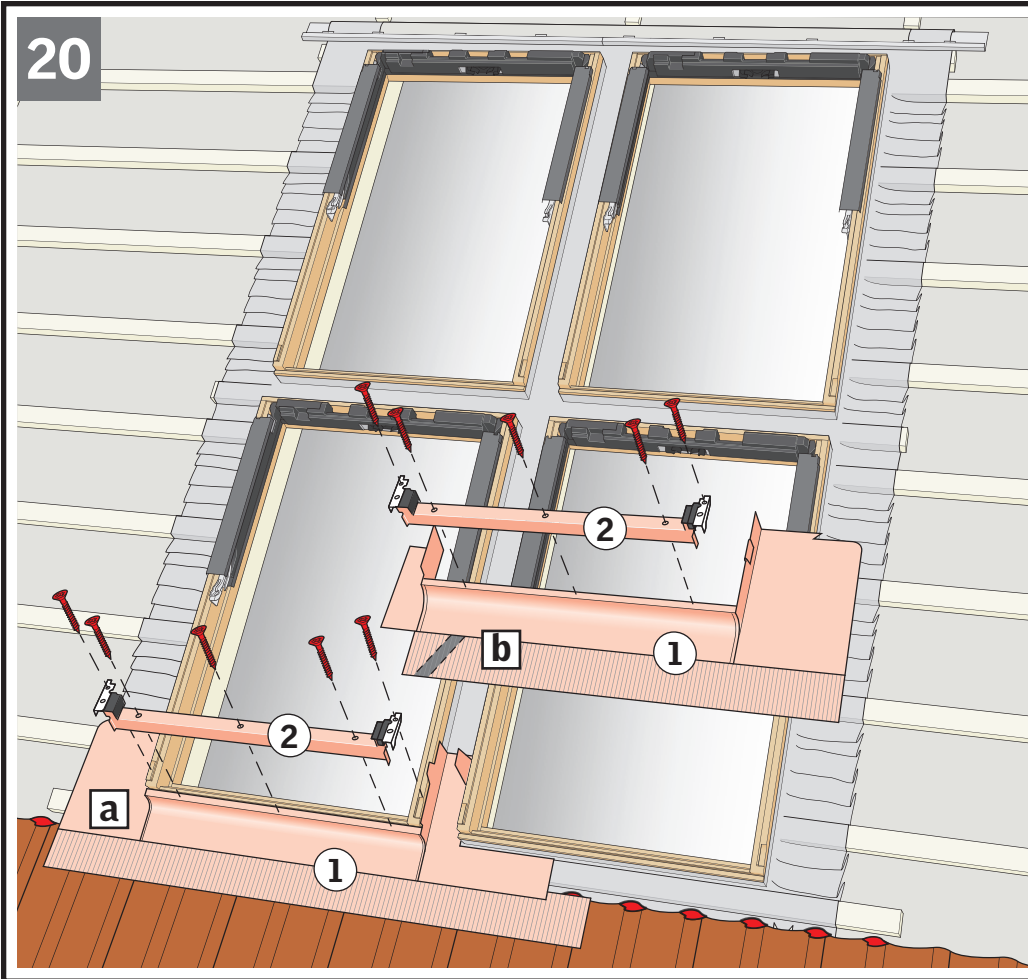

22

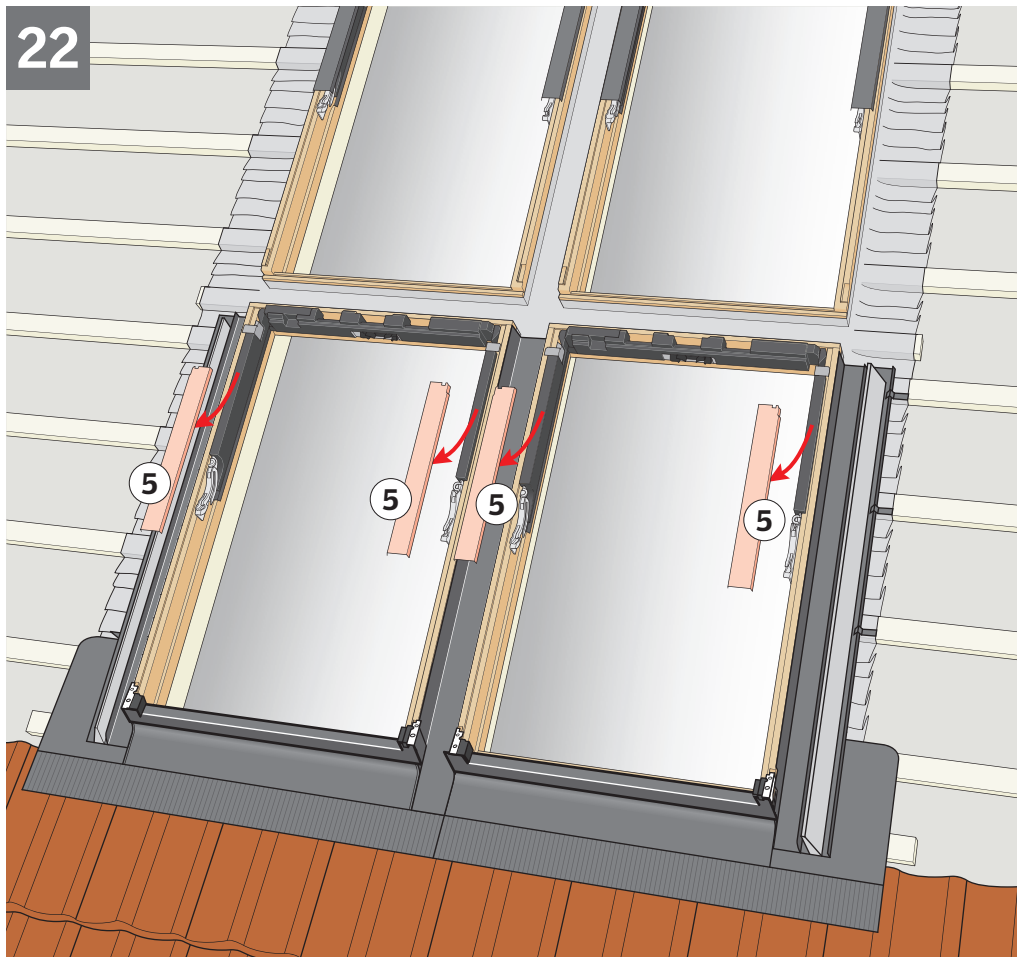

New

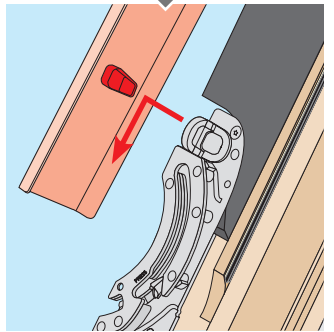
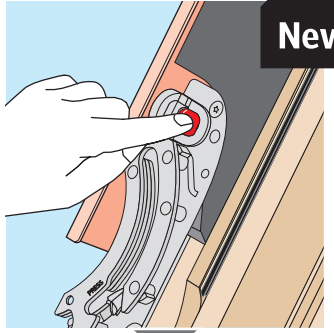

23

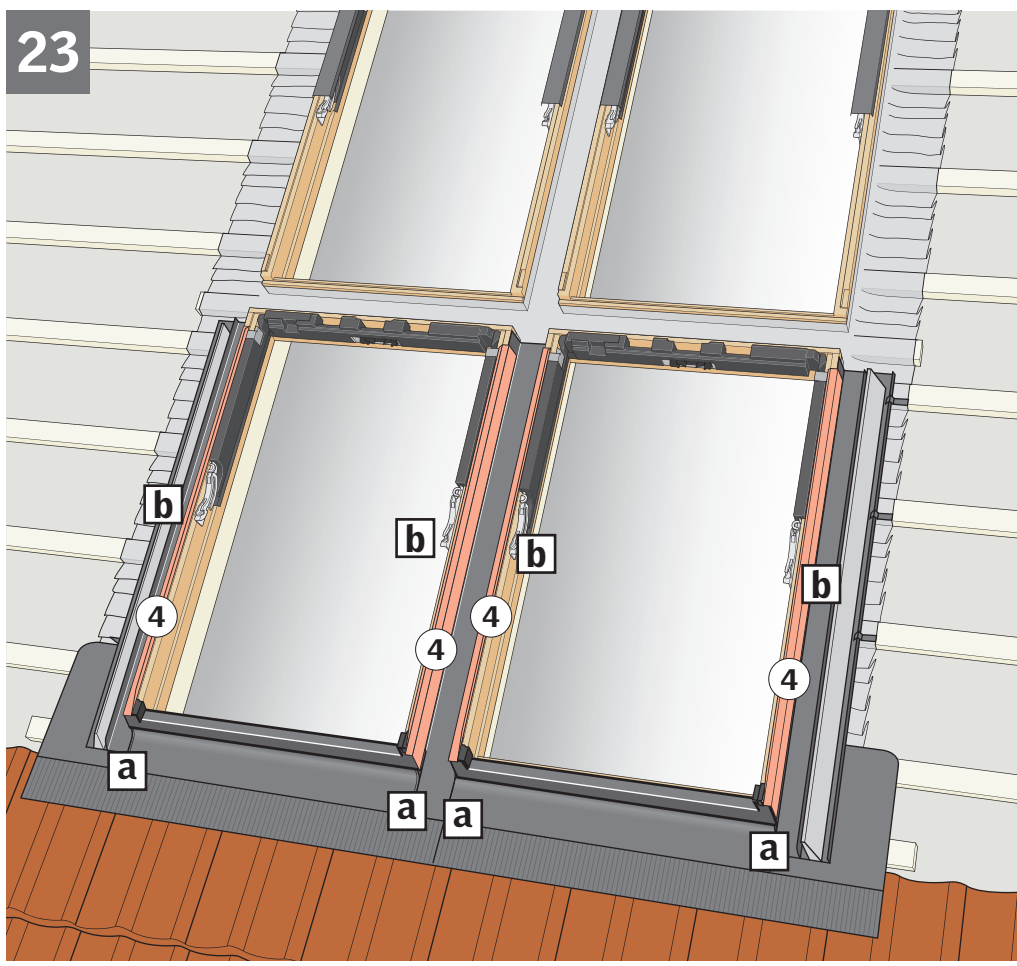

New

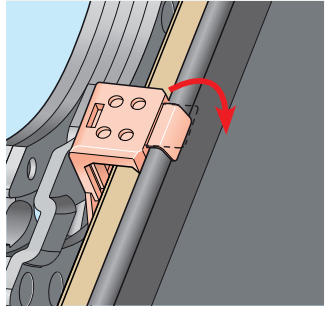
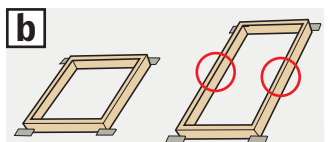
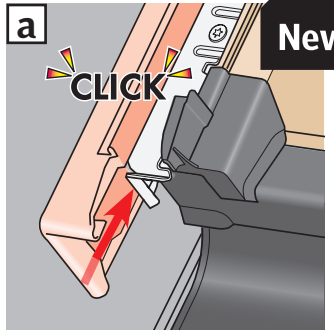

24

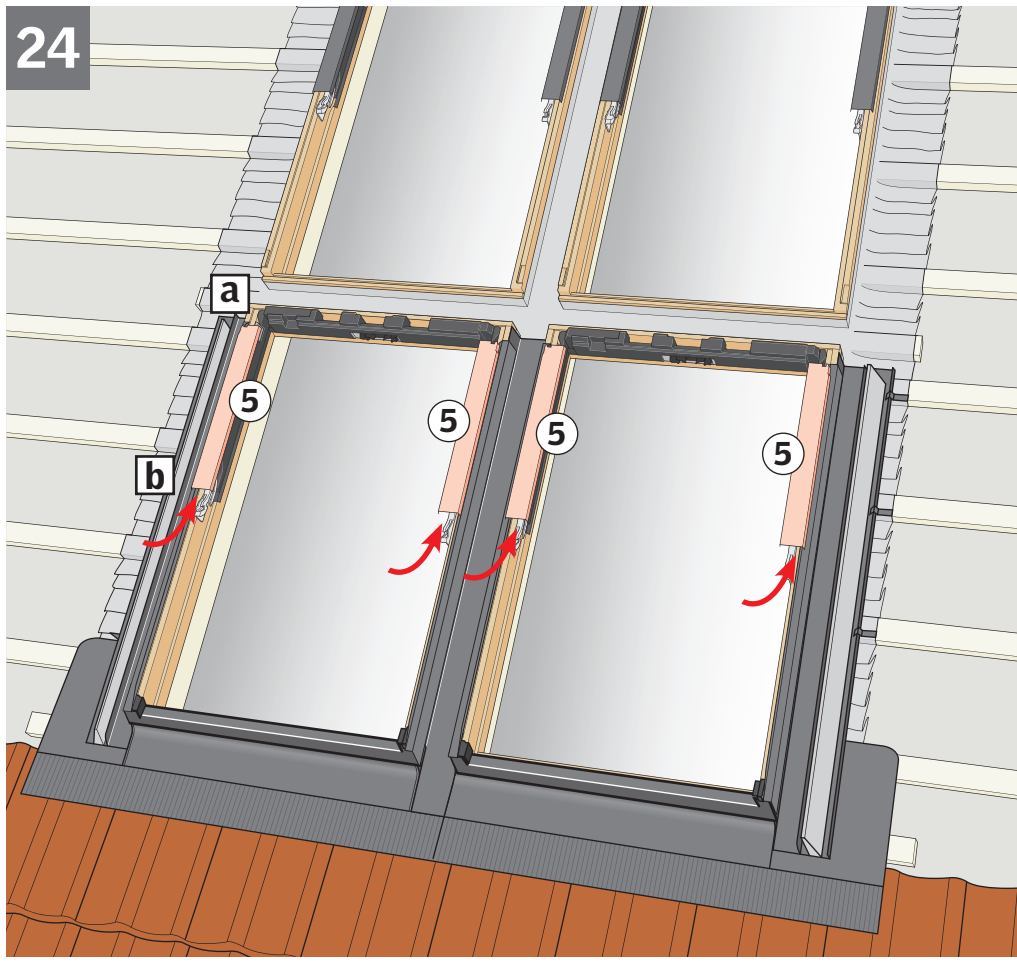

New

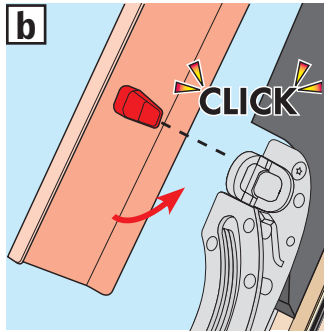
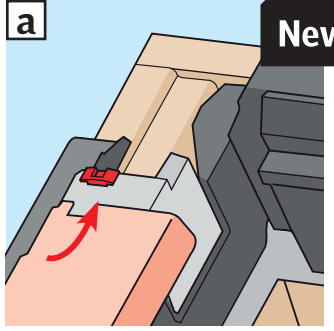

25

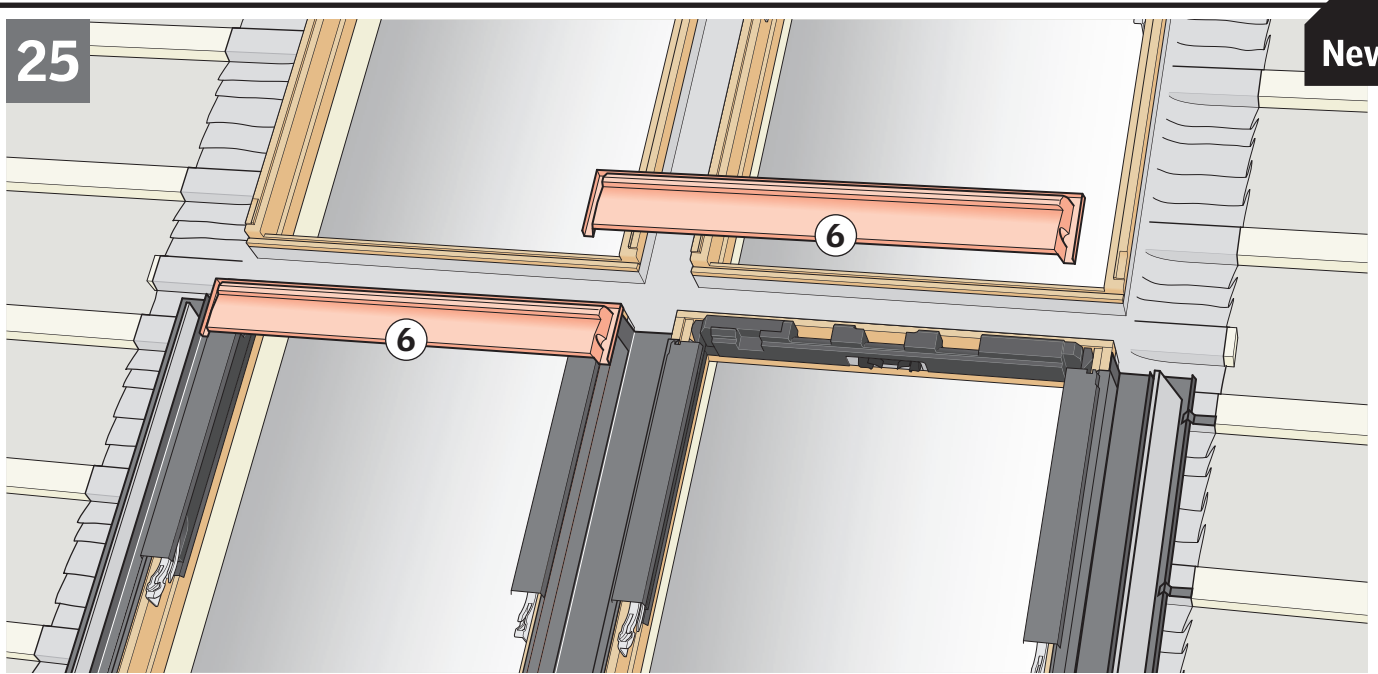

New

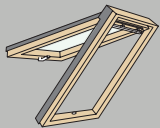

GPL / GPU
GTL / GDL

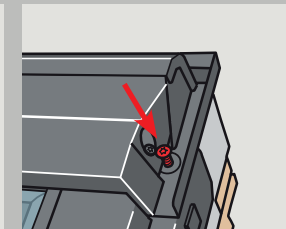
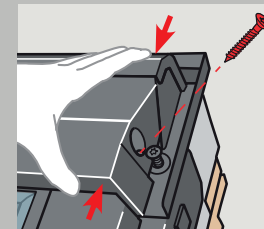
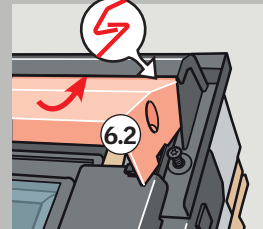
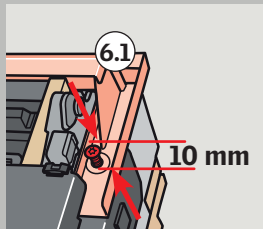

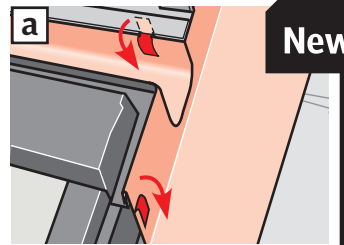
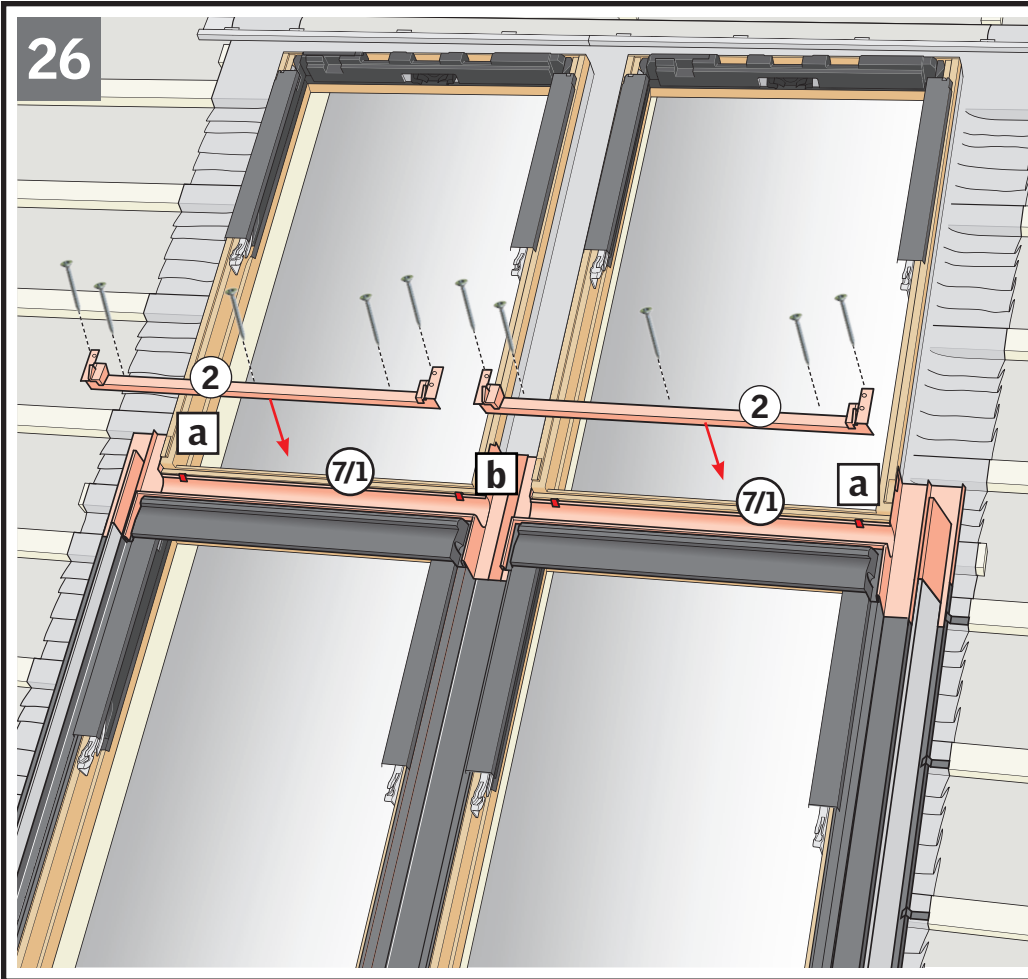

New

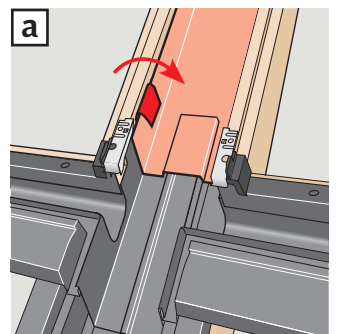
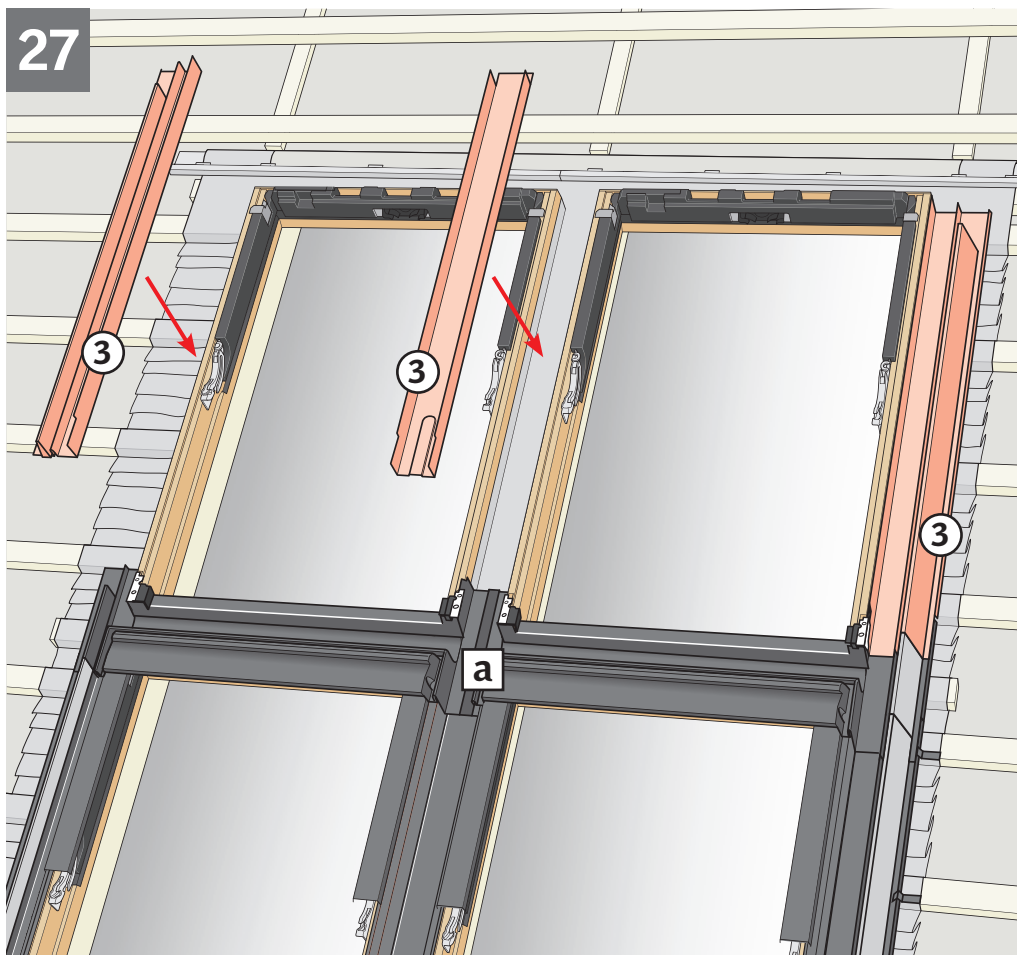
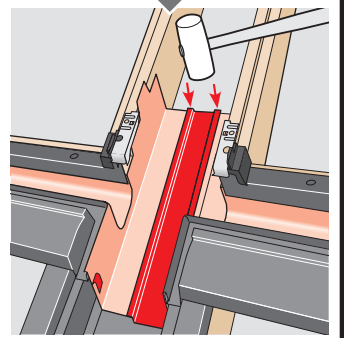
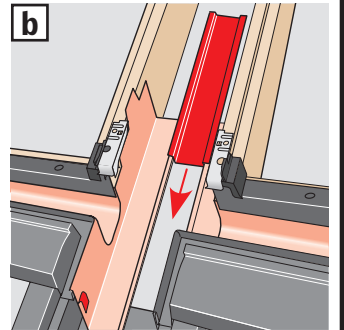

28

New

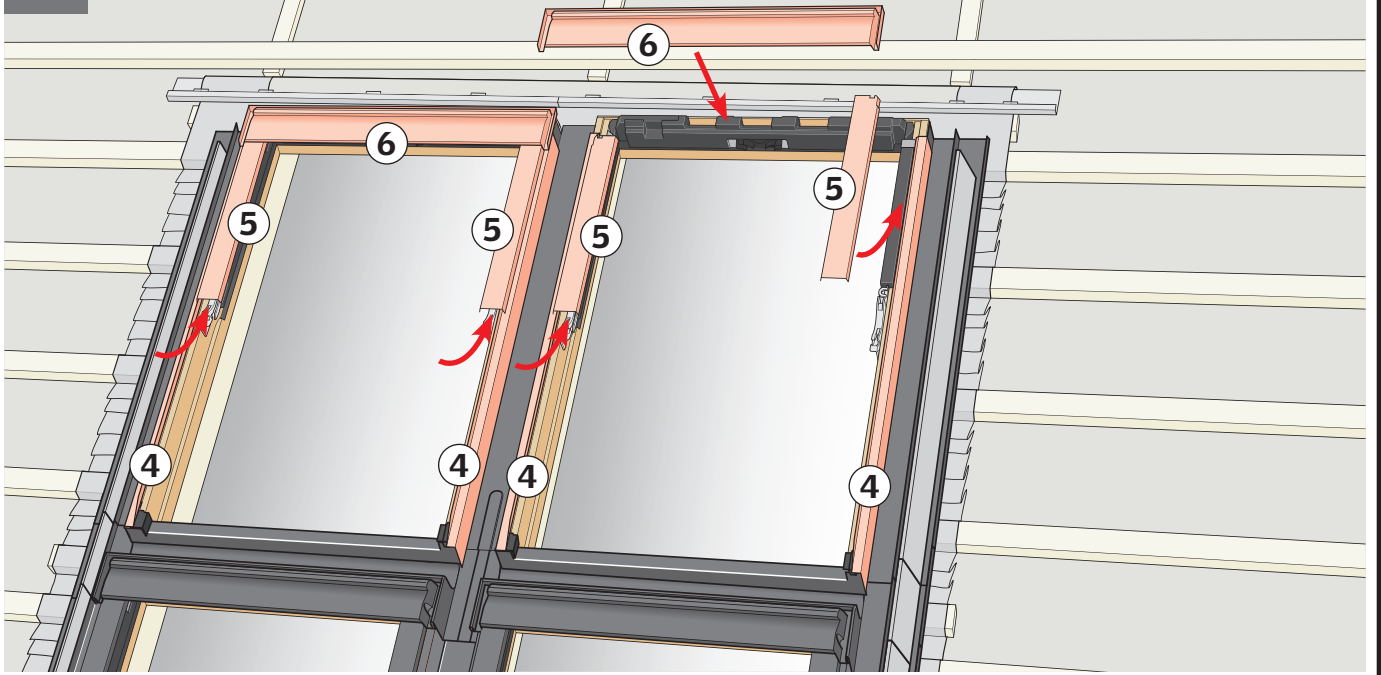

22

23

24

25

29

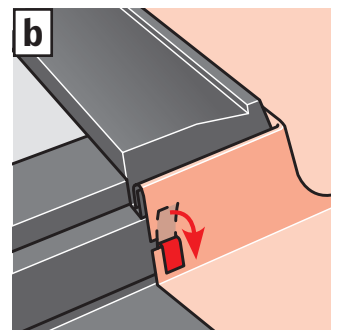
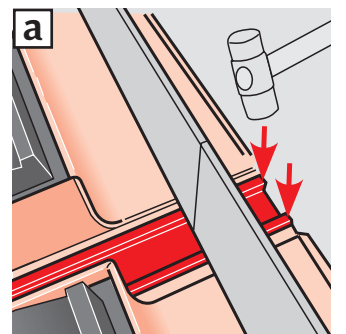
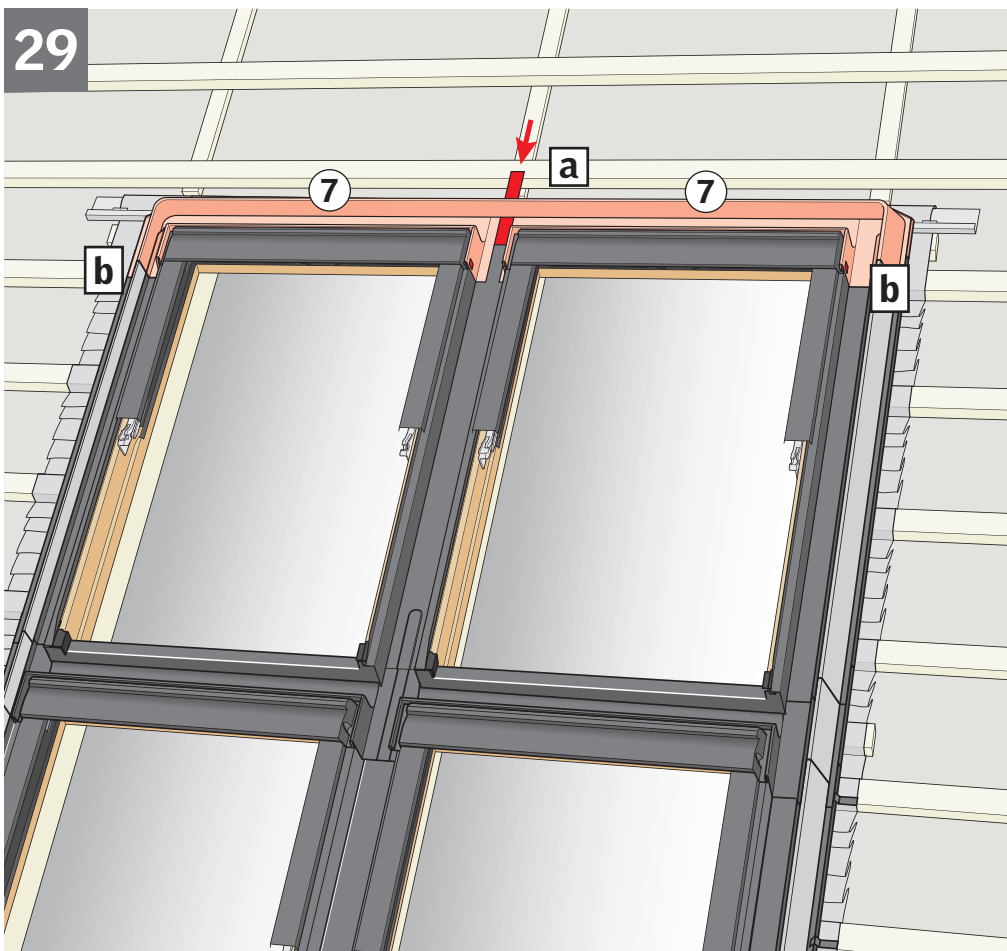

30

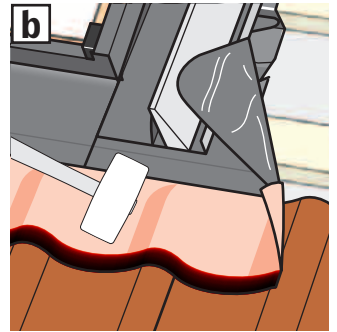
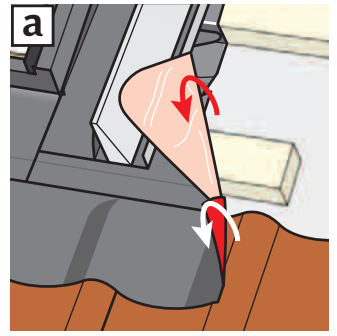
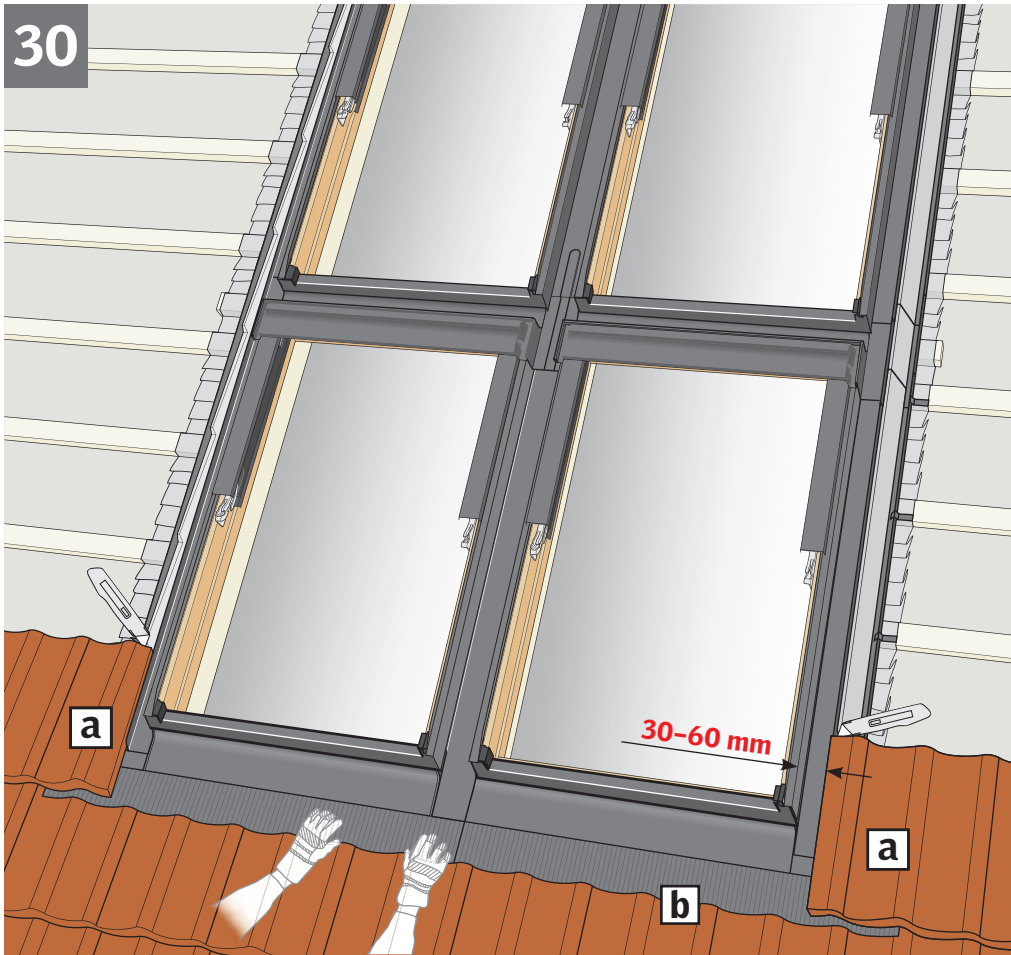

31

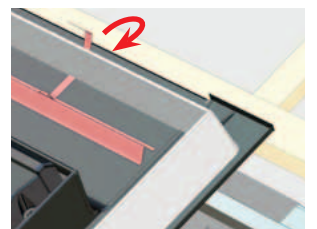
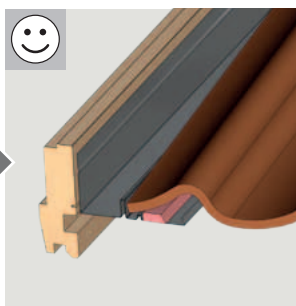
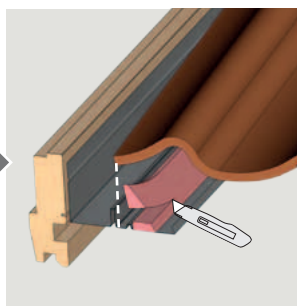
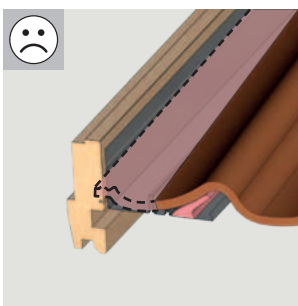
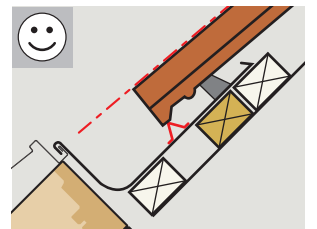
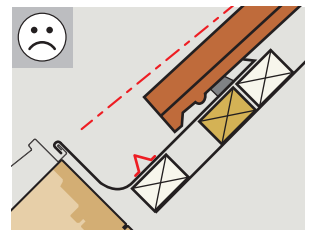
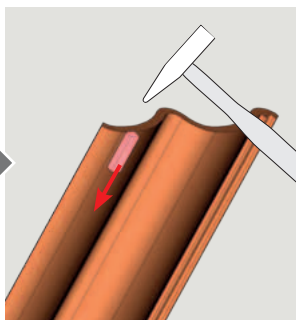
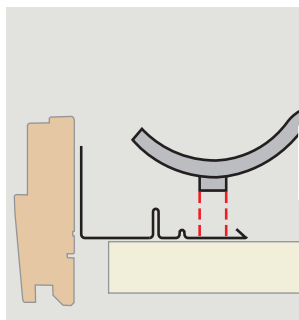
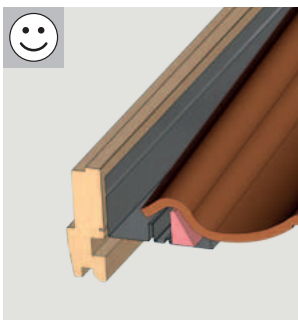
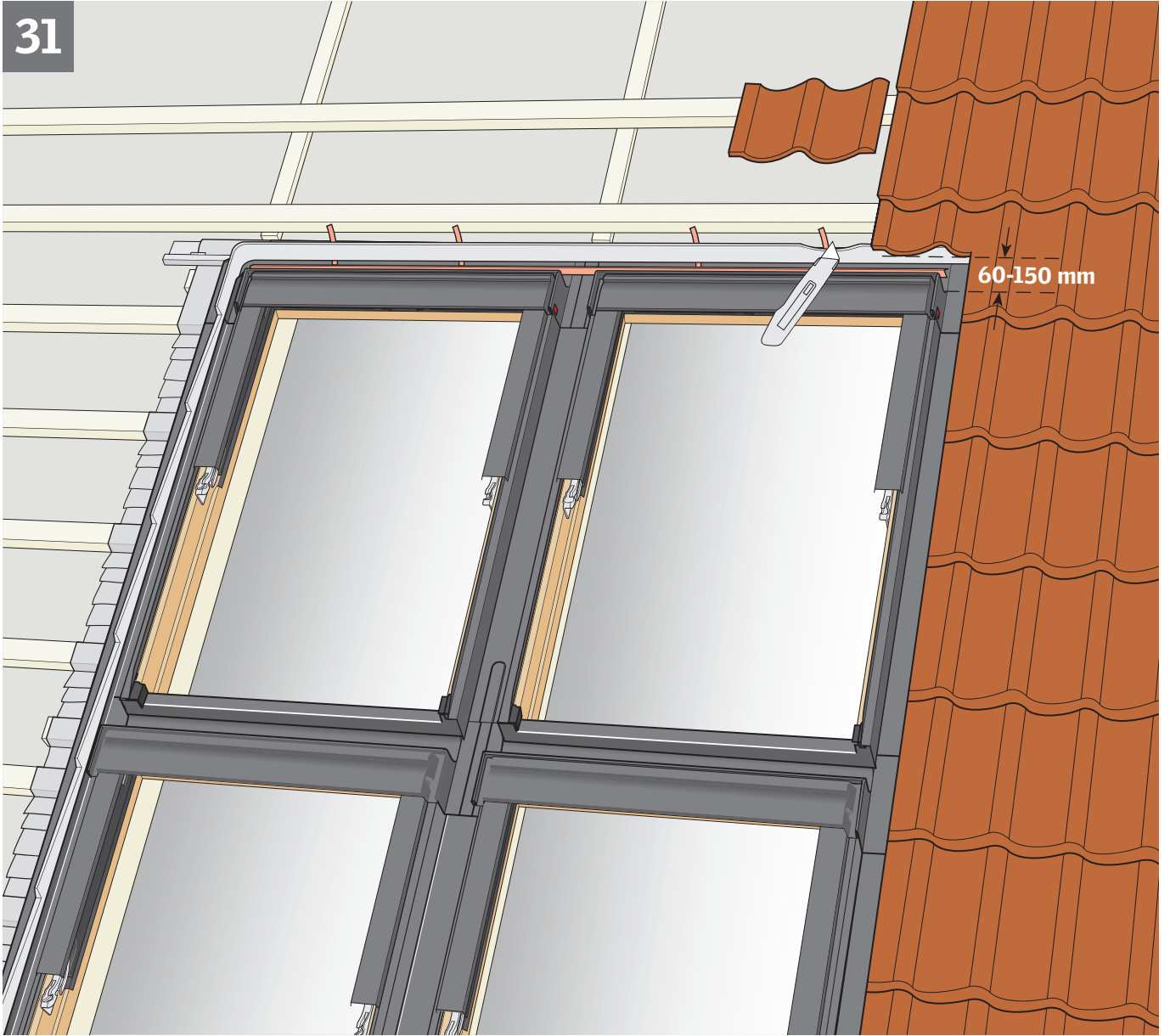

AR: VELUX Argentina S.A. 348 4 639944	EE: VELUX Eesti OÜ 621 7790	NZ: VELUX New Zealand Ltd. 0800 650 445
AT: VELUX Österreich GmbH 02245/32 3 50	ES: VELUX Spain, S.A. 91 509 71 00	PL: VELUX Polska Sp. z o.o. (022) 33 77 000 / 33 77 070
AU: VELUX Australia Pty. Ltd. 1300 859 856	FI: VELUX Suomi Oy 0207 290 800	PT: VELUX Portugal, Lda 21 880 00 60
BA: VELUX Bosna i Hercegovina d.o.o. 033/626 493, 626 494	FR: VELUX France 0821 02 15 15 0,119€ TTC/min	RO: VELUX România S.R.L. 0-8008-83589
BE: VELUX Belgium (010) 42.09.09	GB: VELUX Company Ltd.	RS: VELUX Srbija d.o.o. 011 20 57 500
BG: VELUX Bulgaria EOOD 02/955 99 30	HR: VELUX Hrvatska d.o.o. 01/5555 444	RU: ZAO VELUX (495) 737 75 20
BY: FE VELUX Roof Windows (017) 217 7385	HU: VELUX Magyarország Kft. (06/1) 436-0601	SE: VELUX Svenska AB 042/20 83 80
CA: VELUX Canada Inc. 1 800 88-VELUX (888-3589)	IE: VELUX Company Ltd.	SI: VELUX Slovenija d.o.o. 01 724 68 68
CH: VELUX Schweiz AG 0848 945 549	IT: VELUX Italia s.p.a. 045/6173666	SK: VELUX Slovensko, s.r.o. (02) 33 000 555
CL: VELUX Chile Limitada 2 953 6789	JP: VELUX-Japan Ltd. 0570-00-8145	TR: VELUX Çati Pencereleri Ticaret Limited Şirketi 0 216 302 54 10
CN: VELUX (CHINA) CO. LTD. 0316-607 27 27	LT: VELUX Lietuva, UAB (85) 270 91 01	UA: VELUX Ukraina TOV (044) 2916070
CZ: VELUX Česká republika, s.r.o. 531 015 511	LV: VELUX Latvia SIA 67 27 77 33	US: VELUX America Inc. 1-800-88-VELUX
DE: VELUX Deutschland GmbH 0180-333 33 99	NL: VELUX Nederland B.V. 030 - 6 629 629	
DK: VELUX Danmark A/S 45 16 45 16	NO: VELUX Norge AS 22 51 06 00	